

# International Product Catalogue Hong Kong Edition

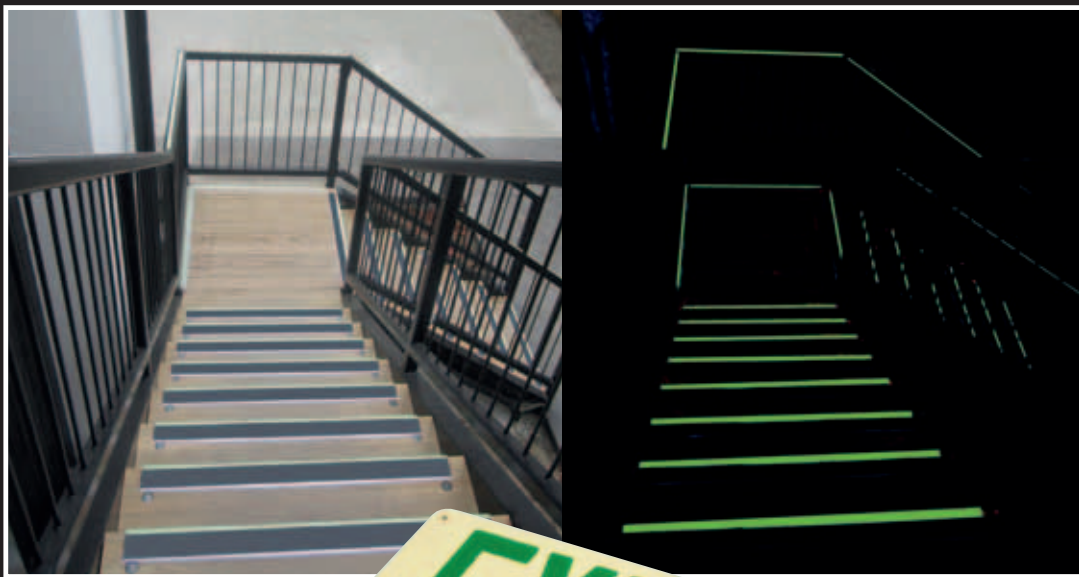

# Contents

Exemplar Projects.....	3
About Ecoglo.....	5
Technical Information.....	6
Exit Signs.....	7 - 12
UL924 PL Exit Signs	
S20 PL Standard Exit Signs	
Hybrid PL Exit Signs	
Living Building Challenge Compliant PL Exit Signs	
Emergency Visibility Products.....	13
Fire Protection Signs.....	20
Disaster Preparedness Signs.....	22
Stadium and Venue Markers.....	26
Specification Documents.....	28 - 48
Exit Signs	
Egress Path Markings	
Fire Protection Signs	
Disaster Preparedness Signs	
Master Format - Egress Path Markings	
Safety Data Sheets.....	49
Maintenance and Cleaning Instructions.....	57

# Exemplar Projects Using Ecoglo Products



1



2



4



3



5



6



7

1. Supreme Court, Singapore
2. US Bank Tower, Los Angeles
3. Burj Khalifa, Dubai
4. Venetian Macao, Macau
5. Eaton Centre, Toronto
6. Yuen Long MTR Station, Hong Kong
7. MCG, Melbourne

 **ecoglo**<sup>®</sup>  
VISIBLY BETTER

# Ecoglo International Transit Projects



New York City Transit - 7th Avenue Station, Brooklyn



London Underground - Shepherds Bush Market Station



Marine Coastal Expressway - Singapore



MTR Corporation, Hong Kong - Yeung Long Station



Toronto Transit Commision - Bloor Street Station



Tokyo Subway



Cahill Tunnel - Sydney

# About Ecoglo



Hong Kong Ecoglo Ltd. represents Ecoglo International in Hong Kong, Macau and China.

Established in 1997, Ecoglo designs and manufactures photoluminescent (PL) exit signs and emergency visibility products using High Temperature Curing (HTC) technology to integrally bond Purpose Designed Polymers (PDP) to the aluminium base. This results in products with very high light storage capabilities and unparalleled durability.

Performance solutions can be engineered to meet emergency visibility requirements in performance based building codes worldwide. Ecoglo offers products to meet NFPA 101 Life Safety Code Solutions and IFC Solutions which includes our patented HTC product set alongside a range of PVC tapes and products.

By harvesting sunlight or recycling the existing light in a building, Ecoglo PL products provide sustainable and cost effective building solutions. The solutions are fail-safe, operate immediately and will last the life of a building (PL characteristics of Ecoglo HTC products are warranted for 30 years for indoor use).

Research and development has focused on refining Ecoglo's patented manufacturing process to create products that have superior durability,

rapid charging and predictable visibility. This development programme has led to the design and manufacture of a range of emergency exit signs – including the Hybrid PL Sign – and evacuation route products. The patented LED/PL hybrid exit sign is a breakthrough in power usage and storage.

Ecoglo products can be seen in many renowned international facilities, including Melbourne Cricket Ground, New York's Jazz at Lincoln Center, Toronto's Eaton Centre, London's Bond St Underground Station and Dubai's Coca Cola Arena and 160 floor Burj Khalifa.

Notable facilities using Ecoglo exit signage include Toronto's Union Station, Qudos Bank Arena (formerly Sydney Olympics 2000 Arena) and Christchurch Hospital Acute Services Building.

Building codes around the world are recognising the contribution that such products make, not only to effective and economical emergency visibility systems, but also to the environment. Countries that have already adopted this technology into their respective building codes include the USA, Canada, Australia, Japan and New Zealand.



## Ecoglo's HTC (High Temperature Curing) Manufacturing Process

The photoluminescent pigments in Ecoglo products absorb and store both natural and recycled electric light which is then re-emitted as a glow when the lights go out.

To ensure Ecoglo products are not susceptible to peeling, shrinkage and delamination like many other inferior photoluminescent products, Ecoglo uses a patented high temperature curing (HTC) manufacturing process.

HTC involves the precisely controlled application of a powder mix of customised photoluminescent pigments and customised carriers (referred to as Purpose Designed Polymer or PDP) onto an aluminium base. The polymer mix and aluminium base pass through a bespoke oven to be baked at temperatures above 160°C. This high temperature curing process integrally bonds the polymer mix to the aluminium, eliminating the possibility of peeling, shrinkage or delamination. It also provides permanent protection of the photoluminescent pigments from degradation due to moisture or weathering. These performance properties cannot be guaranteed for photoluminescent PVC products or tapes, or liquid applied products. HTC products won't suffer from shrinkage, delamination or discolouring and are therefore more durable delivering higher and more reliable luminance and visibility.

For more information and HTC Q & A see  
[www.hongkongecoglo.com](http://www.hongkongecoglo.com)>TECHNICAL>HTC.



## Installation

Ecoglo provides comprehensive installation instructions for all our products, and also provides on-site cutting instructions for our E Series and F Series step products. All instructions are available for download from [www.hongkongecoglo.com](http://www.hongkongecoglo.com).

Although Ecoglo installations are usually carried out by building contractors, almost anyone can get involved. If the installer is unsure about any aspect of an installation they should contact us at [info@ecoglo.com](mailto:info@ecoglo.com).

## Best Practice Specifications

Ecoglo has produced a Best Practice Specification document for each of the following products:

1. Exit Signs
2. Egress Path Markers
3. Fire Protection Signs
4. Disaster Preparedness Signs

Each specification document is a comprehensive guide to installing and maintaining photoluminescent systems to meet international performance based building codes including NFPA 101 and IFC/IBC. Email [Specification@ecoglo.com](mailto:Specification@ecoglo.com) or download from [www.hongkongecoglo.com](http://www.hongkongecoglo.com)

## Compliance Guides

### IFC/IBC

Ecoglo designs and manufactures products to meet 2015 International Fire Code (IFC) Section 1025 Luminous Egress Path Markings and has produced a compliance guide detailing where Ecoglo egress path marking systems are required, which Ecoglo markings should be used and where they should be installed.

### NFPA 101

Ecoglo designs and manufactures products to meet 2015 NFPA 101 Life Safety Code 7.2.2.5.5 Exit Stair Path Markings and has produced a compliance guide detailing where Ecoglo exit stair path marking systems are required, which Ecoglo markings should be used and where they should be installed.

Both Compliance Guides are available for download under Code Compliance at [www.hongkongecoglo.com](http://www.hongkongecoglo.com)

## Warranty

The photoluminescent performance of Ecoglo signs and products, manufactured using our High Temperature Curing (HTC) process, is warranted for a period of 30 years from date of installation when positioned indoors, and 15 years from date of installation for outdoor signs (specially coated for outdoor conditions) and products when positioned outdoors.

The photoluminescent performance of non-HTC products is warranted for a period of three years from date of installation for products which are positioned indoors only.

Comprehensive warranty details are available for download from [www.hongkongecoglo.com](http://www.hongkongecoglo.com)

# Ecoglo Exit Signs



Note: Check Product Data Sheet and website  
([www.hongkongecoglo.com](http://www.hongkongecoglo.com)) for code compliance information

# UL 924 PL Exit Signs

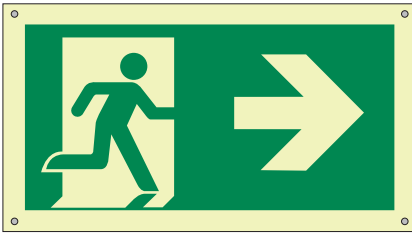

## Pictogram Right Arrow

Exit right from here

**Maximum Viewing Distance:** 50 feet

**Product No:** S20-UL-RMR392223-50

**Size** 392mm x 223mm

**Maximum Viewing Distance:** 75 feet

**Product No:** S20-UL-RMR480280-75

**Size** 480mm x 280mm

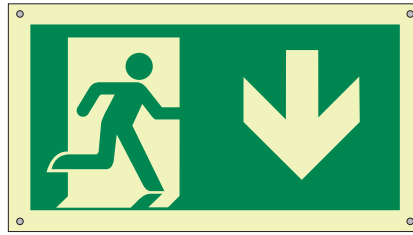

## Pictogram Down Arrow

Exit down from here

**Maximum Viewing Distance:** 50 feet

**Product No:** S20-UL-RMDA392223-50

**Size** 392mm x 223mm

**Maximum Viewing Distance:** 75 feet

**Product No:** S20-UL-RMDA480280-75

**Size** 480mm x 280mm

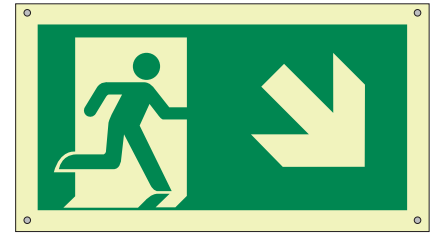

## Pictogram Down Right Arrow

Exit down right from here

**Maximum Viewing Distance:** 50 feet

**Product No:** S20-UL-RMDR392223-50

**Size** 392mm x 223mm

**Maximum Viewing Distance:** 75 feet

**Product No:** S20-UL-RMDR480280-75

**Size** 480mm x 280mm



## Pictogram Left Arrow

Exit left from here

**Maximum Viewing Distance:** 50 feet

**Product No:** S20-UL-RML392223-50

**Size** 392mm x 223mm

**Maximum Viewing Distance:** 75 feet

**Product No:** S20-UL-RML480280-75

**Size** 480mm x 280mm



## Pictogram Up Right Arrow

Exit up right from here

**Maximum Viewing Distance:** 50 feet

**Product No:** S20-UL-RMUR392223-50

**Size** 392mm x 223mm

**Maximum Viewing Distance:** 75 feet

**Product No:** S20-UL-RMUR480280-75

**Size** 480mm x 280mm

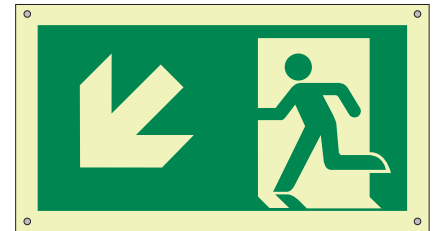

## Pictogram Down Left Arrow

Exit down left from here

**Maximum Viewing Distance:** 50 feet

**Product No:** S20-UL-RMDL392223-50

**Size** 392mm x 223mm

**Maximum Viewing Distance:** 75 feet

**Product No:** S20-UL-RMDL480280-75

**Size** 480mm x 280mm

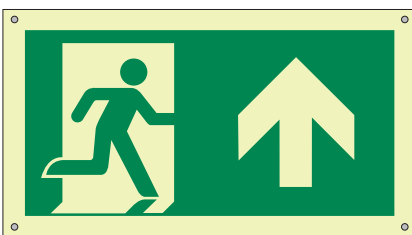

## Pictogram Up Arrow

Exit straight on from here

**Maximum Viewing Distance:** 50 feet

**Product No:** S20-UL-RMUA392223-50

**Size** 392mm x 223mm

**Maximum Viewing Distance:** 75 feet

**Product No:** S20-UL-RMUA480280-75

**Size** 480mm x 280mm

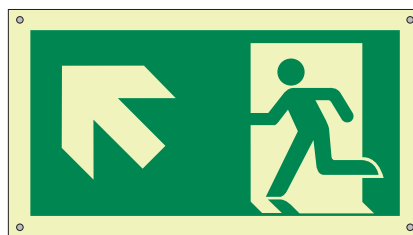

## Pictogram Up Left Arrow

Exit up left from here

**Maximum Viewing Distance:** 50 feet

**Product No:** S20-UL-RMUL392223-50

**Size** 392mm x 223mm

**Maximum Viewing Distance:** 75 feet

**Product No:** S20-UL-RMUL480280-75

**Size** 480mm x 280mm



## Exit

Exit straight on from here

**Maximum Viewing Distance:** 50 feet

**Product No:** S20-UL-EX392223-50

**Size** 353mm x 183mm

**Maximum Viewing Distance:** 75 feet

**Product No:** S20-UL-EX480280-75

**Size** 481mm x 249mm



# UL 924 PL Exit Signs



## Exit Left

Exit left from here

**Maximum Viewing Distance:** 50 feet

**Product No:** S20-UL-EXL392223-50

**Size** 353mm x 183mm

**Maximum Viewing Distance:** 75 feet

**Product No:** S20-UL-EXL480280-75

**Size** 481mm x 249mm



## Exit Right

Exit right from here

**Maximum Viewing Distance:** 50 feet

**Product No:** S20-UL-EXR392223-50

**Size** 353mm x 183mm

**Maximum Viewing Distance:** 75 feet

**Product No:** S20-UL-EXR480280-75

**Size** 481mm x 249mm



## Exit Double Arrow

Exit straight on from here

**Maximum Viewing Distance:** 50 feet

**Product No:** S20-UL-EXRL392223-50

**Size** 353mm x 183mm

**Maximum Viewing Distance:** 75 feet

**Product No:** S20-UL-EXRL480280-75

**Size** 481mm x 249mm

# S20 PL Standard Exit Signs



## Exit

Exit straight on from here

**Maximum Viewing Distance:** 16 metres

**Product No:** S20-EX2313-16m

**Size** 230mm x 133mm

**Maximum Viewing Distance:** 24 metres

**Product No:** S20-EX2916-24m

**Size** 290mm x 162mm



## Pictogram

Exit straight on from here

**Maximum Viewing Distance:** 16 metres

**Product No:** S20-RM2916-16m

**Size** 290mm x 162mm

**Maximum Viewing Distance:** 24 metres

**Product No:** S20-RM4223-24m

**Size** 420mm x 230mm



## Pictogram Left

Exit left from here

**Maximum Viewing Distance:** 16 metres

**Product No:** S20-RML2916-16m

**Double Sided** DSS20-RMD2916-16m

**Size** 290mm x 162mm

**Maximum Viewing Distance:** 24 metres

**Product No:** S20-RML4223-24m

**Double Sided** DSS20-RMD4223-24m

**Size** 420mm x 230mm

# S20 PL Standard Exit Signs



## Pictogram Uni

Exit straight on from here  
**Maximum Viewing Distance:** 16 metres  
**Product No:** S20-RM1616UN-16m  
**Size** 162mm x 162mm

**Maximum Viewing Distance:** 24 metres  
**Product No:** S20-RM2323UN-24m  
**Size** 230mm x 230mm



## Arrow

Travel in this direction  
**Product No:** S20-AR1313  
**Size** 133mm x 133mm  
**For use with:** S20-EX2313-16m

**Product No:** S20-AR1616  
**Size** 162mm x 162mm  
**For use with:** S20-RM1616-16m  
and S20-EX2916-24m

**Product No:** S20-AR2323  
**Size** 230mm x 230mm  
**For use with:** S20-RM2323-24m

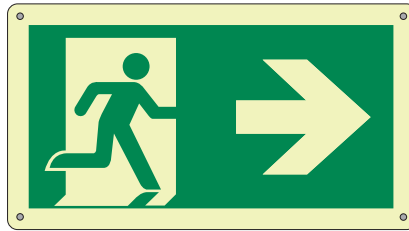

## Pictogram Right

Exit right from here  
**Maximum Viewing Distance:** 16 metres  
**Product No:** S20-RMR2916-16m  
**Double Sided** DSS20-RMD2916-16m  
**Size** 290mm x 162mm

**Maximum Viewing Distance:** 24 metres  
**Product No:** S20-RMR4223-24m  
**Double Sided** DSS20-RMD4223-24m  
**Size** 420mm x 230mm



## No Exit

Do not use this door to exit in an emergency  
**Maximum Viewing Distance:** 16 metres  
**Product No:** S20-NE4113-16m  
**Size** 410mm x 133mm

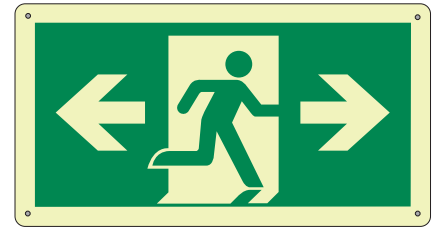

## Pictogram Double Arrow

Exit right or left from here  
**Maximum Viewing Distance:** 16 metres  
**Product No:** S20-RMRL2916-16m  
**Double Sided:** DSS20-RMRL2916-16m  
**Size** 290mm x 162mm

**Maximum Viewing Distance:** 24 metres  
**Product No:** S20-RMRL4223-24m  
**Double Sided:** DSS20-RMRL4223-24m  
**Size** 420mm x 230mm



## Emergency Exit

Use this door only to exit in an emergency  
**Maximum Viewing Distance:** 16 metres  
**Product No:** S20-EE6128-16m  
**Size** 610mm x 280mm

**Maximum Viewing Distance:** 24 metres  
**Product No:** S20-EE7835-24m  
**Size** 785mm x 350mm

## Mounting / Hanging Signs

### Standard Mounting Brackets



FLAG MOUNT



CEILING MOUNT

### Chain Suspension for Signs

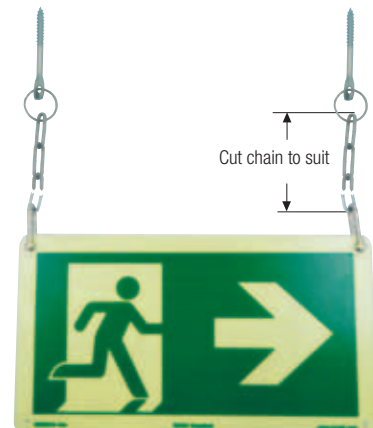

Contact Ecoglo for product data sheet or download from [www.hongkongecoglo.com](http://www.hongkongecoglo.com)

# Hybrid PL Exit Signs



Can be surface, ceiling or flag mounted



Sign can also be recessed into ceiling

The Hybrid PL exit sign is available single sided or double sided with a range of mounting options to satisfy architectural requirements.

Single sided sign (HYU1.2) or Double sided sign (HYU2.2)

Flag mount kit: BR3-16m-FM

Ceiling recess kit: BR3-16m-CR

Wall and ceiling mounting options included with sign

Signs include one or more of graphics shown below.



RM  
Exit straight on from here



RML  
Exit left from here



RMR  
Exit right from here



RM DOUBLE ARROW  
Exit right or left from here



RM (Low Light)  
Exit straight on from here



EXIT (Low Light)  
Exit straight on from here



EXIT  
Exit straight on from here



EXIT LEFT  
Exit left from here



EXIT RIGHT  
Exit right from here

## CEILING AND WALL MOUNT

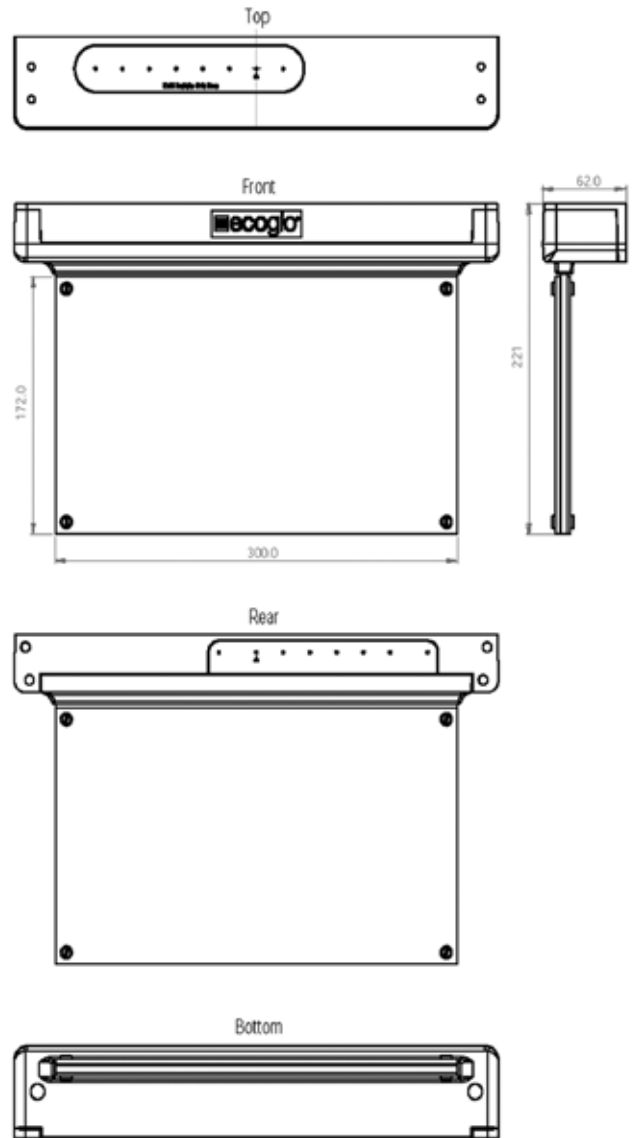

Contact Ecoglo for product data sheet  
or download from [www.hongkongecoglo.com](http://www.hongkongecoglo.com)

# Living Building Challenge PL Exit Signs

## Red List Free Exit Signs - BR2-LBC



CEILING MOUNT



FLAG MOUNT



SURFACE MOUNT

The Ecoglo BR2-LBC Series of mounted photoluminescent Exit signs are designed for architectural perfection without costing the Earth. The signs have no 'Red List' ingredients (as per the Living Building Challenge Red List) and are warranted for 30 years when installed indoors so can be expected to last the life of the building.

The chic aluminium cover plate offers a sleek architectural appearance that will complement any interior space. Suitable for indoor use where architectural designs with first class aesthetics and performance are required.

### Ecoglo BR2-LBC Series Exit Signs consist of:

- A Living Building Challenge compliant exit sign which has no 'Red List' ingredients
- Acrylic faceplate and backing plate
- Anodised aluminium mounting plates

## Declare.

Ecoglo BR2-LBC signs are currently the only exits signs on the Declare database –  
see <https://declare.living-future.org/products/ecoglo-exit-signs-br2-lbc>

Contact Ecoglo for product data sheet or download from [www.hongkongecoglo.com](http://www.hongkongecoglo.com)

# Ecoglo Emergency Visibility Products



Note: Check Product Data Sheet and website  
([www.hongkongecoglo.com](http://www.hongkongecoglo.com)) for code compliance information

## F15-175 Step Nosing 75mm x 33mm

Available in standard lengths from 800mm to 1500mm in 100mm increments

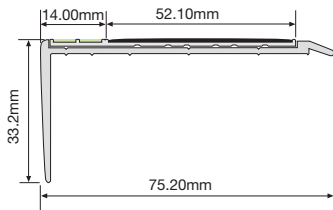
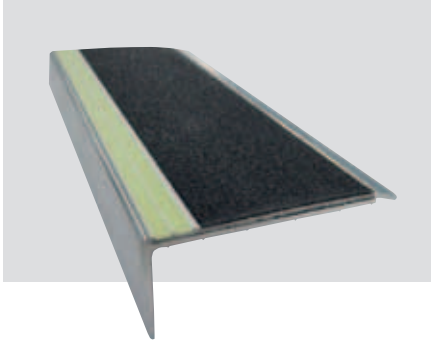

- Supplied pre-drilled with fixers.
- Adhesive and caulking gun available separately
- Custom cutting is available from 2450mm and 3060mm lengths

## F14-175 Step Nosing 75mm x 10mm

Available in standard lengths from 800mm to 1500mm in 100mm increments

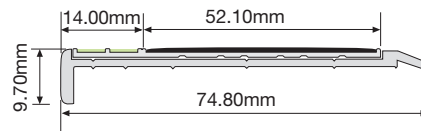
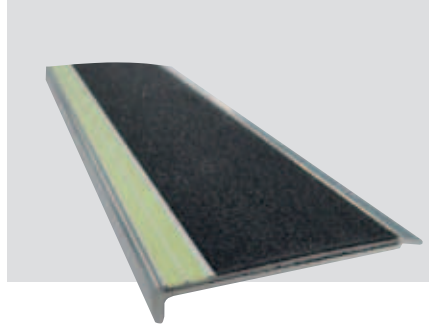

- Supplied pre-drilled with fixers.
- Adhesive and caulking gun available separately
- Custom cutting is available from 2450mm and 3060mm lengths

## F14-173 Step Nosing 75mm x 10mm

Available in standard lengths from 800mm to 1500mm in 100mm increments

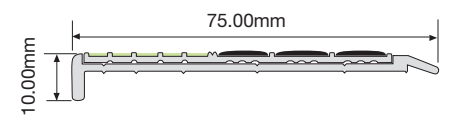
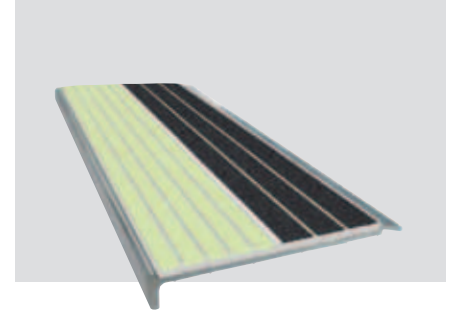

- Supplied pre-drilled with fixers.
- Adhesive and caulking gun available separately
- Custom cutting is available from 2450mm and 3060mm lengths

## MADE TO ORDER

## F15-173 Step Nosing 75mm x 33mm

Available in standard lengths from 800mm to 1500mm in 100mm increments

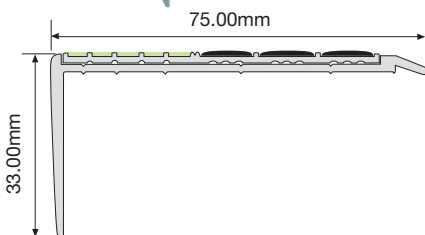
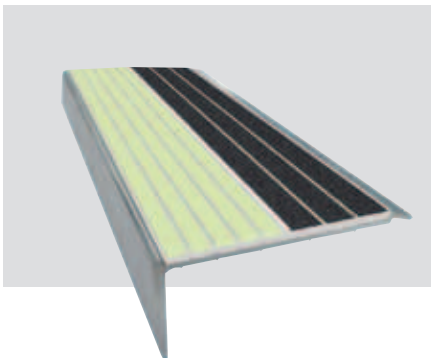

- Supplied pre-drilled with fixers.
- Adhesive and caulking gun available separately
- Custom cutting is available from 2450mm and 3060mm lengths

## F15-155 Step Nosing 75mm x 33mm

Available in standard lengths from 800mm to 1500mm in 100mm increments

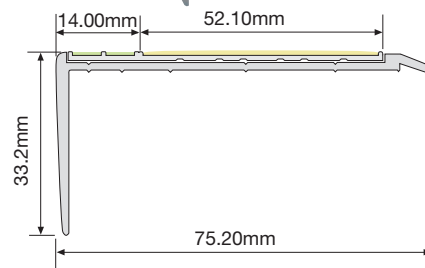
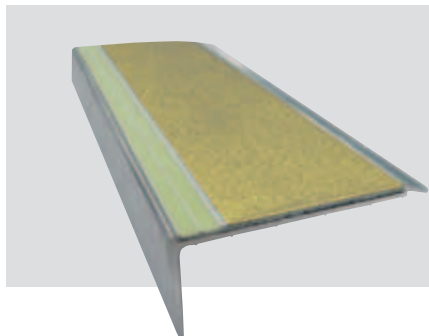

- Supplied pre-drilled with fixers.
- Adhesive and caulking gun available separately
- Custom cutting is available from 2450mm and 3060mm lengths

## F14-155 Step Nosing 75mm x 10mm

Available in standard lengths from 800mm to 1500mm in 100mm increments

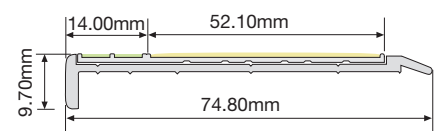
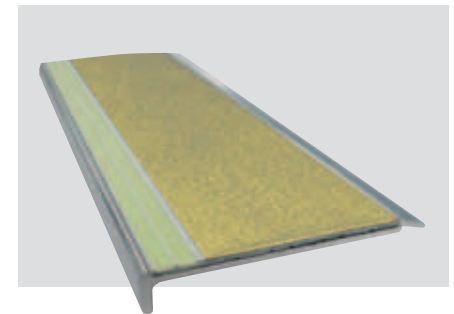

- Supplied pre-drilled with fixers.
- Adhesive and caulking gun available separately
- Custom cutting is available from 2450mm and 3060mm lengths

Contact Ecoglo for product data sheet or download from [www.hongkongecoglo.com](http://www.hongkongecoglo.com)

## F2-003 Step Nosing 77mm x 22mm

Available in standard lengths from 800mm to 1500mm in 100mm increments

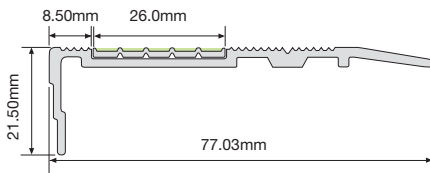
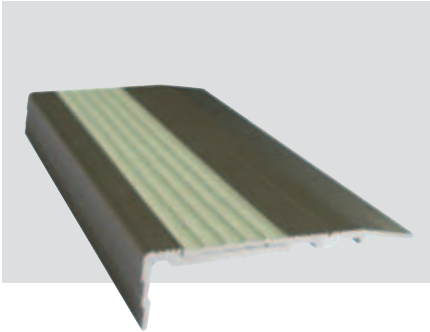

- Supplied pre-drilled with fixers.
- Adhesive and caulking gun available separately
- Custom cutting is available from 2450mm and 3060mm lengths
- Custom - hidden fixers

## E14-075 Step Edge Contrast 64mm

Available in standard lengths from 800mm to 1500mm in 100mm increments

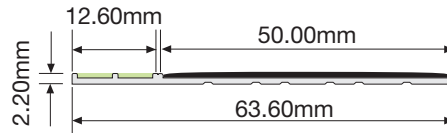
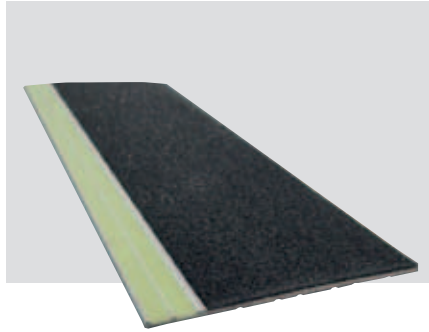

- Adhesive and caulking gun available separately
- Custom cutting is available from 2450mm and 3060mm lengths

**E14-075** Polyurethane adhesive fixing  
**E14-075P** Punched for screw fixing

## E15-073 Step Edge Contrast 64mm

Available in standard lengths from 800mm to 1500mm in 100mm increments

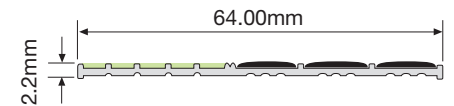
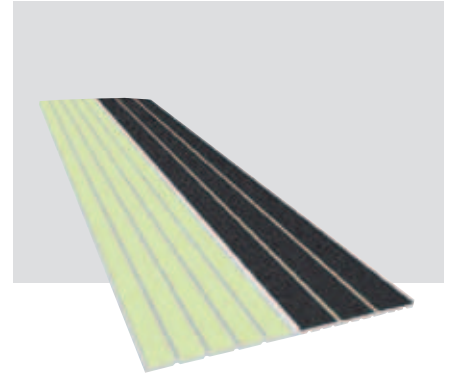

- Supplied pre-drilled with fixers.
- Adhesive and caulking gun available separately
- Custom cutting is available from 2450mm and 3060mm lengths

### MADE TO ORDER

## E4-073 Step Edge Contrast 51mm

Available in standard lengths from 800mm to 1500mm in 100mm increments

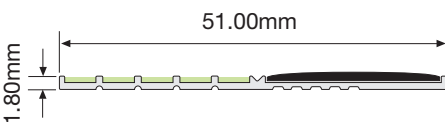
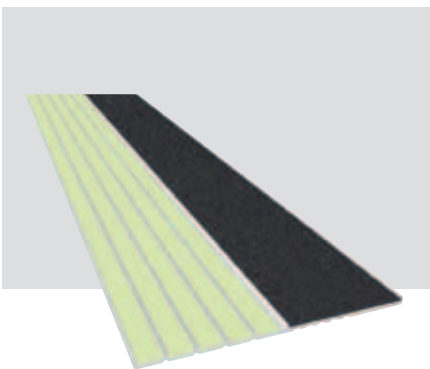

- Adhesive and caulking gun available separately
- Custom cutting is available from 2450mm and 3060mm lengths
- Custom colours are available to meet AS 1428.1 luminance contrast for any surface colour

**E4-073** For polyurethane adhesive fixing  
**E4-073P** Punched for screw fixing

## E2-071 Step Edge Contrast 37mm

Available in standard lengths from 800mm to 1500mm in 100mm increments

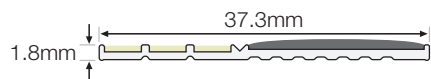
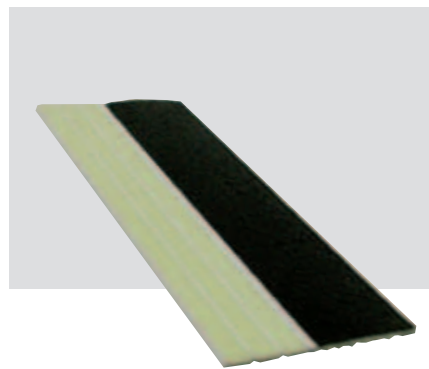

- Adhesive and caulking gun available separately
- Custom cutting is available from 2450mm and 3060mm lengths

**E2-071** Polyurethane adhesive fixing  
**E2-071P** Punched for screw fixing

## E14-055 Step Edge Contrast 64mm

Available in standard lengths from 800mm to 1500mm in 100mm increments

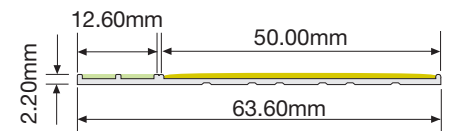
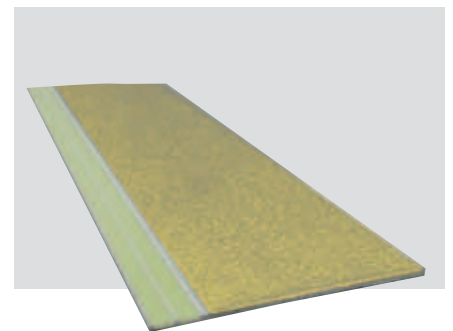

- Adhesive and caulking gun available separately
- Custom cutting is available from 2450mm and 3060mm lengths

**E14-055** Polyurethane adhesive fixing  
**E14-055P** Punched for screw fixing

## G6-003 Guidance Strip 26mm

Available in 1000mm and 3060mm lengths

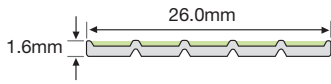
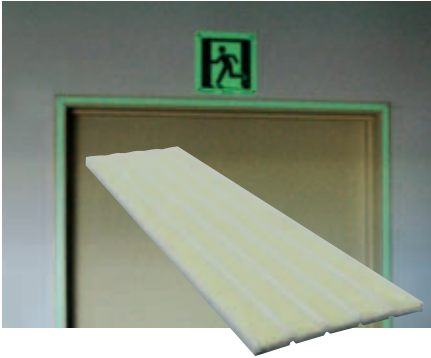

- G6-003-1000 Polyurethane adhesive fixing
- G6-003-3060 Polyurethane adhesive fixing
- G6-003P-1000 Punched for screw fixing
- G6-003P-3060 Punched for screw fixing
- G6-003T-1000 Release tape pre-fitted
- G6-003T-3060 Release tape pre-fitted

## G3-001 Guidance Strip 16mm

Available in 1000mm and 3060mm lengths

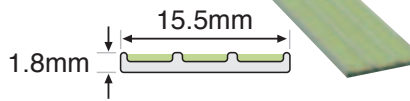

- G3-001-1000 Polyurethane adhesive fixing
- G3-001-3060 Polyurethane adhesive fixing
- G3-001P-1000 Punched for screw fixing
- G3-001P-3060 Punched for screw fixing
- G3-001T-1000 Release tape pre-fitted

## MS-26 Handrail Wall Strip 26mm

Available in 1000mm lengths

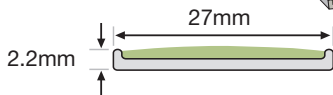
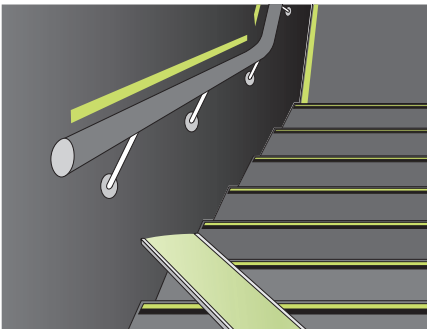

- MS-26T-1000 Release tape pre-fitted

## H3-001 Handrail Marker 16mm

Available in 1000mm and 3060mm lengths

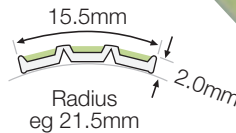
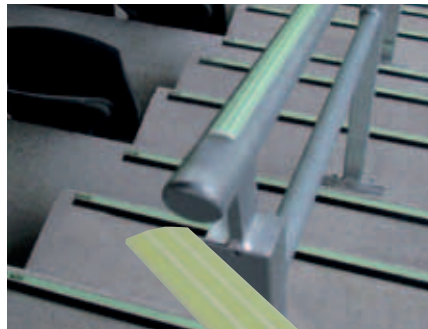

- H3-001-1000 Polyurethane adhesive fixing
- H3-001-3060 Polyurethane adhesive fixing
- H3-001T-1000 Release tape pre-fitted
- H3-001T-3060 Release tape pre-fitted

## H5-001 Handrail Marker 127mm

Available in 1000mm and 3060mm lengths

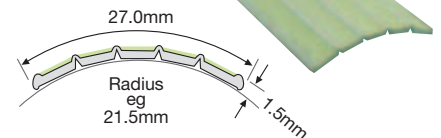

- H5-001-1000 Polyurethane adhesive fixing
- H5-001-3060 Polyurethane adhesive fixing
- H5-001T-1000 Release tape pre-fitted
- H5-001T-3060 Release tape pre-fitted

## HREC3 Metal End Cap



### END CAPS

Metal end cap to fit H3-001

## HEC5 Plastic End Cap



### END CAPS

Plastic end cap to fit H5-001

Contact Ecoglo for product data sheet or download from [www.hongkongecoglo.com](http://www.hongkongecoglo.com)



## G7-100 Solaris Path Marker

Available in 1000mm lengths

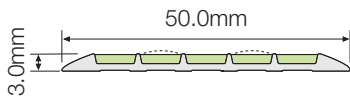
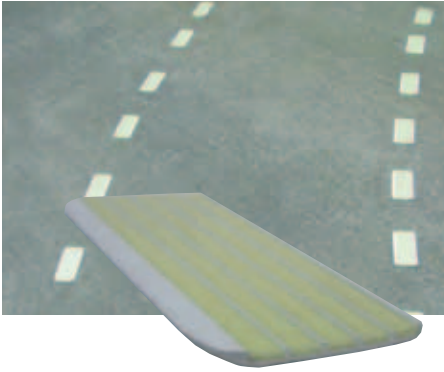

**G7-100** Polyurethane adhesive fixing  
**G7P-100** Punched for screw fixing  
**G7T-100** Release tape pre-fitted

## T5-101 Path Marker

Available in 1000mm lengths

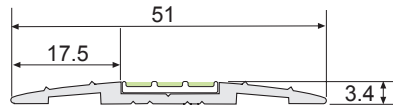
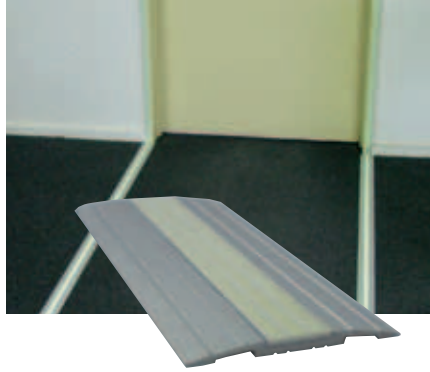

**T5-101-1000** Polyurethane adhesive fixing  
**T5-101P-1000** Punched for screw fixing

## T6-101 Path Marker

Available in 1000mm lengths

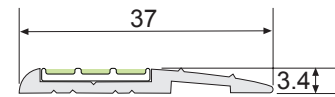
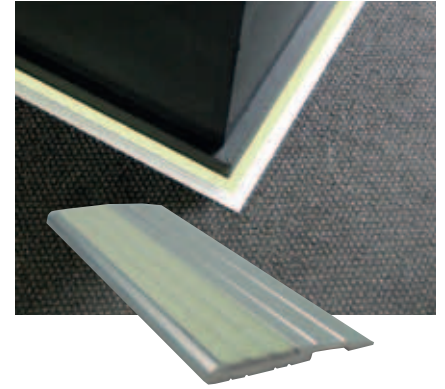

**T6-101-1000** Polyurethane adhesive fixing  
**T6-101P-1000** Punched for screw fixing

## Door Handle Marker

Use this to highlight a door handle in an emergency

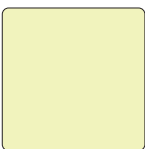

60mm x 60mm

**S20-SQ-60** - Release tape pre-fitted

## Door Handle Marker

Use this to highlight a door handle in an emergency



100mm x 100mm

**S5-DHM1010** Release tape pre-fitted

## Directional Signs



### Directional Pictogram Left Facing

Exit straight on from here  
Product No. S5-RML1010  
Size 100mm x 100mm



### Directional Pictogram Right Facing

Exit straight on from here  
Product No. S5-RMR1010  
Size 100mm x 100mm

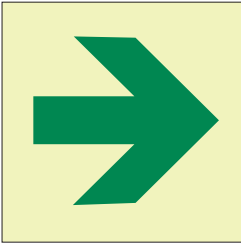

### Directional Arrow Straight

Travel in this direction  
Product No. S5-ARS1010  
Size 100mm x 100mm

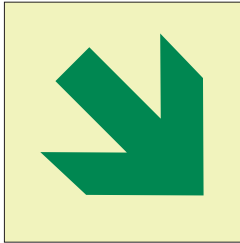

### Directional Arrow Diagonal

Travel in this direction  
Product No. S5-ARS1010  
Size 100mm x 100mm

## Stairway Identification Sign



### Stairway Identification

Product No. S5-SI4631  
Size 460mm x 310mm

Contact Ecoglo for product data sheet or download from [www.hongkongecoglo.com](http://www.hongkongecoglo.com)

## Miscellaneous Products

### Adhesive for Emergency Visibility Products

#### Caulking Gun

CLKGUN-600ml  
To take 600ml Adhesive Sausage

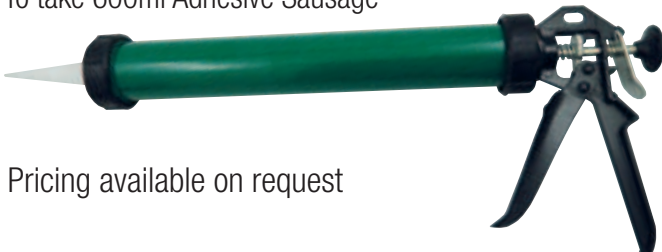

Pricing available on request

#### Polyurethane Adhesive

890100182KD



Pricing available on request

## Vinyl Hazard Tape

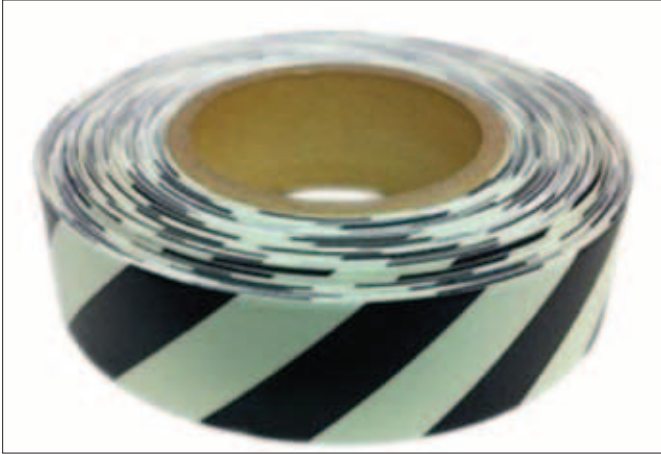

### UL-HZ2518 Hazard Tape

25mm x 3m roll of photoluminescent adhesive vinyl tape

Use this to highlight obstacles along the escape route

**UL-HZ2518** 25mm wide x 18m roll

## Vinyl Photoluminescent Tape

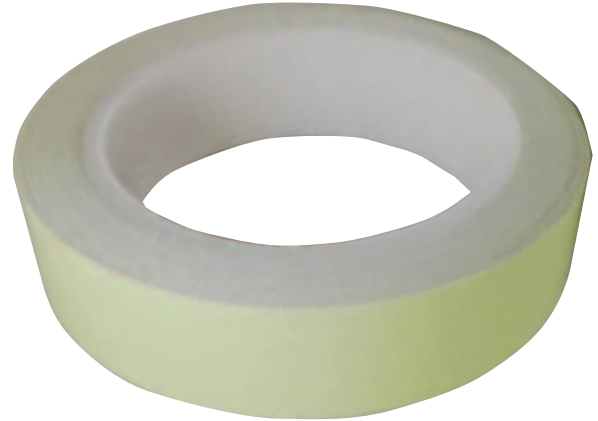

### UL-PT2518 Photoluminescent Tape

25mm x 3m roll of photoluminescent adhesive vinyl tape

Use this to highlight specified features in escape routes

**UL-PT2518** 25mm wide x 18m roll

## Vinyl Push Bar Marker



### UL-DHM3840

38mm x 407mm - Supplied with pre-fitted release tape

Use this to highlight a door push bar

**UL-DHM3840** Door Push Bar Marker

# Ecoglo Fire Protection Signs



Note: Check Product Data Sheet and website  
([www.hongkongecoglo.com](http://www.hongkongecoglo.com)) for code compliance information

## Evacuation Map



### Evacuation Map

- Emergency Evacuation Plan  
Product No. S5-EVAC216330  
Size 216mm x 330mm
- Product No. S5-EVAC457610  
Size 457mm x 610mm
- Product No. S5-EVAC610915  
Size 610mm x 915mm
- Product No. S5-EVAC216280  
Size 216mm x 280mm
- Product No. S5-EVAC210297  
Size 210mm x 297mm

## Fire Extinguisher



### Fire Extinguisher

- Fire extinguisher located here  
Product No. S5-FEXT228102  
Size 228mm x 102mm

## Directional Signs



### Directional Pictogram Left Facing

- Exit straight on from here  
Product No. S5-RML1010  
Size 100mm x 100mm



### Directional Pictogram Right Facing

- Exit straight on from here  
Product No. S5-RMR1010  
Size 100mm x 100mm

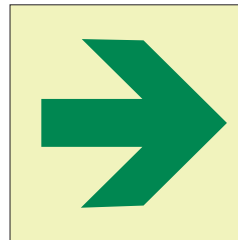

### Directional Arrow Straight

- Travel in this direction  
Product No. S5-ARS1010  
Size 100mm x 100mm

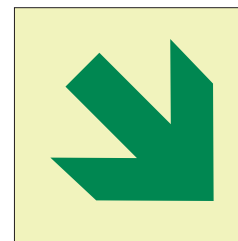

### Directional Arrow Diagonal

- Travel in this direction  
Product No. S5-ARS1010  
Size 100mm x 100mm

# Ecoglo Disaster Preparedness Signs



Note: Check Product Data Sheet and website  
([www.hongkongecoglo.com](http://www.hongkongecoglo.com)) for code compliance information

## Tsunami Hazard Zone

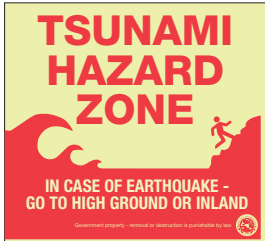

Product No: S20-THZ315290 Size 315mm x 290mm

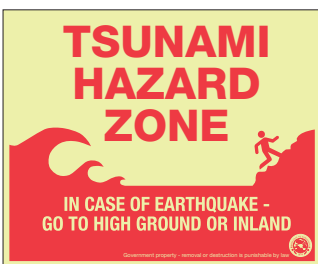

Product No: S20-THZ588475 Size 588mm x 475mm

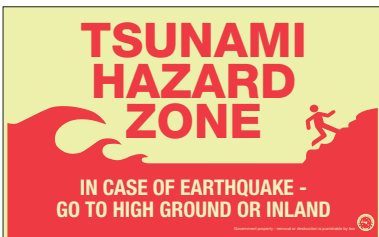

Product No: S20-THZ950588 Size 950mm x 588mm



Product No: S20-THZ1190980 Size 1190mm x 980mm



Product No: S20-THZ2380980 Size 2380mm x 980mm

## Landslide Warning



Product No: S20-LS351290 Size 315mm x 290mm



Product No: S20-LS588475 Size 588mm x 475mm



Product No: S20-LS950588 Size 950mm x 588mm



Product No: S20-LS1190980 Size 1190mm x 980mm



Product No: S20-LS2380980 Size 2380mm x 980mm

Please note graphics above are examples only. Customisation of the artwork is available for different provinces, regions or offices. Contact Ecoglo for more information.

Contact Ecoglo for product data sheet or download from [www.hongkongecoglo.com](http://www.hongkongecoglo.com)

## Evacuation Area Straight Ahead



**Product No:** S20-EA351290 **Size** 315mm x 290mm



**Product No:** S20-EA588475 **Size** 588mm x 475mm



**Product No:** S20-EA950588 **Size** 950mm x 588mm



**Product No:** S20-EA1190980 **Size** 1190mm x 980mm



**Product No:** S20-EA2380980 **Size** 2380mm x 980mm

## Evacuation Area Left



**Product No:** S20-EAL351290 **Size** 315mm x 290mm



**Product No:** S20-EAL588475 **Size** 588mm x 475mm



**Product No:** S20-EAL950588 **Size** 950mm x 588mm



**Product No:** S20-EAL1190980 **Size** 1190mm x 980mm



**Product No:** S20-EAL2380980 **Size** 2380mm x 980mm

Please note graphics above are examples only. Customisation of the artwork is available for different provinces, regions or offices. Contact Ecoglo for more information.

Contact Ecoglo for product data sheet or download from [www.hongkongecoglo.com](http://www.hongkongecoglo.com)



## Evacuation Area Right



**Product No:** S20-EAR351290 **Size** 315mm x 290mm



**Product No:** S20-EAR588475 **Size** 588mm x 475mm



**Product No:** S20-EAR950588 **Size** 950mm x 588mm



**Product No:** S20-EAR1190980 **Size** 1190mm x 980mm



**Product No:** S20-EAR2380980 **Size** 2380mm x 980mm

## Tsunami Evacuation Route



Exit straight ahead from here

**Product No.** TE315155 **Size** 315mm x 155mm



Exit left from here

**Product No.** TEL315155 **Size** 315mm x 155mm



Exit right from here

**Product No.** TER315155 **Size** 315mm x 155mm

## Water Depth Gauge



**Product No:** S20-WDG  
**Size** 115mm x 1000mm

*Note: Image is for illustration purposes only. Each Water Depth Gauge is custom printed to specific requirements for each location.*

Please note graphics above are examples only. Customisation of the artwork is available for different provinces, regions or offices. Contact Ecoglo for more information.

Contact Ecoglo for product data sheet or download from [www.hongkongecoglo.com](http://www.hongkongecoglo.com)

# Ecoglo Stadium and Venue Markers



Note: Check Product Data Sheet and website  
([www.hongkongecoglo.com](http://www.hongkongecoglo.com)) for code compliance information

## Row and Seat Markers

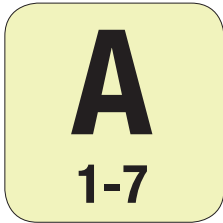

**Row and Seat Marker**  
Product No: SQ90RSP  
Size 90mmx90mm

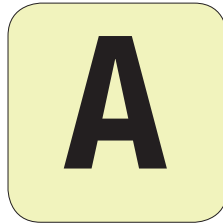

**Row Marker**  
Product No: SQ90R  
Size 90mmx90mm

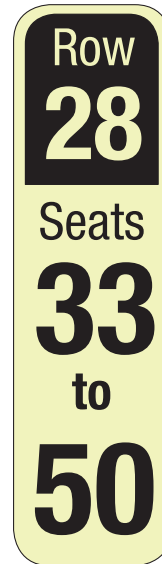

**Row and Seat Marker**  
Product No: RE16045-RS  
Size 160mmx45mm



**Ellipse Seat Marker**  
Product No: EL187567  
Size 18.7mmx56.7mm

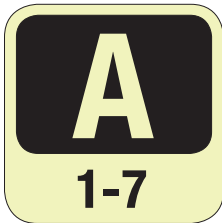

**Row and Seat Marker**  
Product No: SQ90RSN  
Size 90mmx90mm

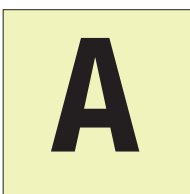

**Row Marker**  
Product No: SQ63R  
Size 63mmx63mm

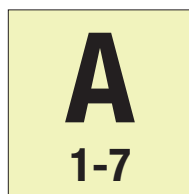

**Row Marker**  
Product No: SQ63RSP  
Size 63mmx63mm



*Note: SQ63R and SQ63RSP markers can fit into F14 and F15 Step Nosings alongside step edge contrast (as above).*

For Emergency Visibility products including Step Markers, Guidance Strips, Path Markers and Handrail Markers see pages 14 - 19, or see Products at [www.hongkongecoglo.com](http://www.hongkongecoglo.com)

# Ecoglo Best Practice Specifications

For a copy of any of the following specification documents  
email [Specification@Ecoglo.com](mailto:Specification@Ecoglo.com)  
or download from [www.hongkongecoglo.com](http://www.hongkongecoglo.com)

## Best Practice Specification

### Part 1 DESCRIPTION

#### 1.01 System Description

Approved photoluminescent exit signs shall identify the Means of Egress and shall be readily visible in all conditions of foreseeable use, including emergency conditions and darkness, and shall be provided in buildings as required by relevant building code.

#### 1.02 Photoluminescent Exit Signs

Photoluminescent exit signs shall be provided to identify all interior and exterior parts of the means of egress including, but not limited to, exit doors, exit stairways, exit ramps and exit passageways, in accordance with 1.02a. and 1.02b. below.

##### a. Locations

The Means of Egress shall be identified by photoluminescent exit signs which are readily visible and shall be located:

- (i) At each point in the Means of Egress where the exit is not immediately visible to occupants;
- (ii) To clearly indicate each door in the Means of Egress; and
- (iii) To clearly identify the direction of travel to reach the nearest exit door.

##### b. Position

Where photoluminescent exit signs are provided to identify a door in the Means of Egress, the sign shall be positioned on a vertical surface within 600 mm of the door and be positioned where it is least likely to be obscured from view and where it cannot be obscured when the door is open.

#### 1.03 Approved Photoluminescent Exit Signs

Approved photoluminescent exit signs shall:

- (A) Have their performance verified by

##### EITHER:

- 1. Independent luminance testing in accordance with ASTM E2073-19, except that the activation illumination in clause 8.3 is replaced with 54 lux, with the minimum luminance levels detailed in following clause 2.04(h);

##### OR

- 2. Testing and listing as per requirements of UL 924 Standard for Emergency Lighting and Power Equipment;

##### AND

- (B) Be produced using a High Temperature Curing (HTC) manufacturing process and independently tested to support the criteria detailed in following clause 2.04i.

##### AND

- (C) Be produced by a manufacturer with ISO 9001 Quality Assurance certification;

##### AND

- (D) Be warranted to last a minimum of 30 years indoors.

#### 1.04 Illumination

Where photoluminescent exit signs are installed, they shall be provided with not less than 54 lux of illumination for not less than 60 minutes prior to periods when the building is occupied, and continuously during the building occupancy.

#### 1.05 Submittals

Documentation as detailed in 1.05a. through 1.05c. must be submitted.

##### a. Manufacturer's Product Data Sheets

Submit Product Data Sheets for product number verification.

##### b. Manufacturer's Installation Instructions

Submit installation instructions.

##### c. Test Reports

Submit independent test reports to verify compliance with relevant standards as detailed in Section 2.04 Performance Criteria.

#### 1.06 Quality Assurance

Submit copy of Manufacturer's ISO 9001-2016 Quality Assurance documentation.

#### 1.07 Warranty

Submit warranty for luminance characteristics for a minimum 30 years of indoor use.

## Best Practice Specification

### Part 2 MATERIALS REQUIREMENTS

#### 2.01 Photoluminescent exit signs

##### a. Acceptable Manufacturer

The manufacturer of the products shall have at least 20 years experience manufacturing photoluminescent materials.

##### b. Authorised Representative

The manufacturer shall have a suitably trained and accredited regional based representative.

#### 2.02 Materials Composition Photoluminescent Exit Signs

Photoluminescent pigment embedded in thermoset polyester manufactured using a High Temperature Curing (HTC) process at a temperature exceeding 160°C to integrally bond the active ingredients to 5005 0.9mm aluminium sheet.

#### 2.03 Approved Photoluminescent Exit Signs

Exit signs for identifying Means of Egress shall consist of materials and be manufactured using processes as defined in section 2.02.

#### 2.04 Performance Criteria

All HTC products to meet or exceed the performance criteria specified in the following tests or standards. PC = Performance Criteria.

##### a. UV Resistance

ASTM G155-04 Cycle 1 1000hrs, Standard Practice for Operating Xenon Arc Light Apparatus for Exposure of Non-metallic Materials.

PC – Loss in luminance after exposure < 10%

##### b. Salt Spray Resistance

ASTM B117-97 Standard Practice for Operating Salt Spray (Fog) Apparatus. PC – Slight corrosion build up along scribes, no blistering or filiform growth along scribes.

##### c. Washability

ASTM D4828-94(2003), Standard Test Methods for Practical Washability of Organic Coatings.

PC – crayon, pen, 3M soil: all rating 10, being complete removal of soilant.

##### d. Rate of Burning

ASTM D635-03, Standard Test Method for Rate of Burning and/or Extent and Time of Burning of Plastics in a Horizontal Position. PC – Time of burn 0 seconds, does not burn.

##### e. Surface Flammability

ASTM E162-02, Standard Test Method for Surface Flammability of Materials Using a Radiant Heat Energy Source.

PC – Flame spread index 7.6, ignites with difficulty.

##### f. Toxicity

Bombardier Toxic Gas Generation Test SMP800-C.

PC - Pass

##### g. Radioactivity

ASTM D3648-2004, Standard Practices for the Measurement of Radioactivity.

PC – Pass

##### h. Luminance

ASTM E2073-19 Standard Test Method for Photopic Luminance of Photoluminescent (Phosphorescent) Markings.

PC - 30mcd/m<sup>2</sup> after 90 minutes of darkness.

OR

UL 924 Standard for Emergency Lighting and Power Equipment.

PC - visible from at least 50 feet (15.24 metres) after 90 minutes of darkness.

##### i. High Temperature Curing

Independently tested by placing 3 samples in an oven at 150°C for 20 minutes and then examining the samples after removing from the oven.

PC - the samples shall have no shrinkage, delamination, distortion or yellowing.

## Best Practice Specification

### Part 3 CONSTRUCTION REQUIREMENTS

#### 3.01 Manufacturer's Instructions

Comply with manufacturer's product data, installation instructions and maintenance and cleaning instructions.

#### 3.02 Examination

Site verification of conditions is required to verify installation surface and appropriate installation method.

#### 3.03 Installation

Installation must be as per manufacturer's installation instructions.

#### 3.05 Cleaning

Maintenance and cleaning should be carried out as per manufacturer's maintenance and cleaning instructions.

### Part 4 METHOD OF MEASUREMENT

#### 4.01 Accepted Quantity of Signs

Exit signs shall be measured by the standard unit to determine the accepted quantity.

#### 4.02 Accepted Quantity of Brackets

Brackets shall be measured by the unit to determine the accepted quantity.

### Part 5 BASIS OF PAYMENT

#### 5.01 Contract Unit Price

The accepted quantities, as determined in Part 4 Method of Measurement, shall be paid at the contract unit prices.

## Best Practice Specification

### Part 1 DESCRIPTION

#### 1.01 System Description

Approved photoluminescent egress path markings as per 1.02 below delineating the Means of Egress shall be provided in buildings as required by relevant building code.

#### 1.02 Markings within Exit Components

Photoluminescent egress path markings shall be provided in all interior and exterior exit stairways, exit ramps and exit passageways of the Means of Egress, in accordance with Sections 1.02a. through 1.02f.

##### a. Steps

A solid and continuous stripe shall be applied to the horizontal leading edge of each step and shall extend to within 50 mm of each end of the leading edge of the step. Stripes shall have a minimum horizontal width of 10 mm and a maximum width of 50 mm. The leading edge of the stripe shall be placed not more than 15 mm from the leading edge of the step and the stripe shall not overlap the leading edge of the step by more than 5 mm down the vertical face of the step.

##### b. Landings

The leading edge of landings shall be marked with a stripe consistent with the dimensional requirements for steps.

##### c. Handrails

Handrails and handrail extensions shall be marked with a solid and continuous stripe having a minimum width of 10 mm. The stripe shall be placed on the top surface of, or inside surface of, or on the wall immediately adjacent to and within 100 mm, of the handrail for the entire length of the handrail. Where handrails or handrail extensions bend or turn corners, the stripe shall not have a gap of more than 100 mm.

##### d. Perimeter Demarcation Lines

Stair landings and other floor areas within all interior and exterior exit stairways, interior and exterior exit ramps and exit passageways, with the exception of the sides of steps, shall be provided with solid and continuous demarcation lines on the floor or on the walls or a combination of both. The stripes shall be 10 mm to 50 mm wide with interruptions not exceeding 100 mm.

Demarcation lines shall not extend in front of or across doors that lead out of an exit through which occupants must travel to complete the Means of Egress.

##### e. Obstacles

Obstacles at or below 2000 mm in height and projecting more

than 100 mm into the egress path shall be outlined with markings not less than 25 mm in width comprised of a pattern of alternating equal bands of photoluminescent material and black.

#### f. Doors within The Means of Egress

Doors through which occupants must pass in order to complete the Means of Egress shall be provided with markings complying with Sections f.(i) through f.(iii).

##### (i) Emergency Exit Symbol

The doors shall be identified by a low-location photoluminescent emergency exit symbol complying with NFPA 170. The exit symbol shall be a minimum of 100 mm in height and shall be mounted on the door, centred horizontally, with the top of the symbol no higher than 500 mm above the finished floor.

##### (ii) Door Hardware Markings

Door hardware shall be marked with no less than 100 mm x 100 mm or equivalent area of photoluminescent material. This marking shall be located behind, immediately adjacent to or on the door handle or escutcheon. Where a panic bar is installed, such material shall be not less than 15 mm wide for the entire length of the actuating bar or touchpad.

##### (iii) Door Frame Markings

The top and sides of the door frame shall be marked with a solid and continuous 10 mm to 50 mm wide stripe. Where the door molding does not provide sufficient flat surface on which to locate the stripe, the stripe shall be permitted to be located on the wall surrounding the frame.

#### 1.03 Approved Photoluminescent Markings

Approved photoluminescent egress path markings shall:

- Be tested to meet UL 1994 and all such products shall be listed with Underwriters Laboratory by the manufacturer; **AND**
- Be produced using a High Temperature Curing (HTC) manufacturing process and independently tested to support the criteria detailed in following clause 2.04j.; **AND**
- Be produced by a manufacturer with ISO 9001 Quality Assurance certification; **AND**
- Be warranted to last a minimum of 30 years indoors.

#### 1.04 Illumination

Where photoluminescent exit path markings are installed, they shall be provided with not less than 10 lux of illumination for not less than 60 minutes prior to periods when the building is occupied, and continuously during the building occupancy.



## Best Practice Specification

### 1.05 Submittals

Documentation as detailed in 1.05a. through 1.05c. must be submitted.

#### a. Manufacturer's Product Data Sheets

Submit Product Data Sheets for product number verification.

#### b. Manufacturer's Installation Instructions

Submit installation instructions.

#### c. Test Reports

Submit independent test reports to verify compliance with relevant standards as detailed in Section 2.04 Performance Criteria.

### 1.06 Quality Assurance

Submit copy of Manufacturer's ISO 9001-2016 Quality Assurance documentation.

### 1.07 Warranty

Submit warranty for luminance characteristics for a minimum 30 years of indoor use.

## Part 2 MATERIALS REQUIREMENTS

### 2.01 Photoluminescent path markings to meet UL 1994

#### a. Acceptable Manufacturer

The manufacturer of the products shall have at least 20 years experience manufacturing photoluminescent materials.

#### b. Authorised Representative

The manufacturer shall have a suitably trained and accredited regional based representative.

### 2.02 Materials Composition

#### a. Aluminium Base Products

- (i) Extruded aluminium nosing profile: 6060T5 or 6063T5 aluminium extrusion.
- (ii) Extruded aluminium inserts for bonding into in nosing profile: Powder coated 6060T5 or 6063T5 aluminium extrusion.
- (iii) Photoluminescent and anti-slip material in aluminium extrusion: Photoluminescent pigment and silicon carbide anti-slip materials embedded in thermoset polyester manufactured using a High Temperature Curing (HTC) process at a temperature exceeding 160°C to integrally bond the active ingredients into the powder coated aluminium insert resulting in the photoluminescent material being recessed into the protective

channels of the powder coated aluminium extrusion.

(iv) Photoluminescent signs and markers:

Photoluminescent pigment embedded in thermoset polyester manufactured using a High Temperature Curing (HTC) process at a temperature exceeding 160°C to integrally bond the active ingredients to 5005 0.9mm aluminium sheet.

### 2.03 Approved Products

#### a. Steps and b. Landings

Step nosings and step edgings for marking step edges and the leading edge of landings consisting of materials and manufactured using processes as defined in section 2.02.

#### c. Handrails

##### Rounded Handrails

Handrail markers for marking of rounded handrails consisting of materials and manufactured using processes as defined in section 2.02.

The handrail strip extrusion is formed to the curvature of the handrail and each end should be finished with an endcap.

##### Flat Handrails

Guidance Strip for marking flat handrails consisting of materials and manufactured using processes as defined in section 2.02.

#### d. Perimeter Demarcation Lines

Guidance strips and path markers for path marking on stair landings, corridors and other floor areas within all interior and exterior exit stairways, interior and exterior exit ramps and exit passageways consisting of materials and manufactured using processes as defined in section 2.02.

#### e. Obstacles

Hazard Marking Tape\* for outlining obstacles projecting into the egress path. Manufactured from high quality vinyl.

*\*Non-HTC product due to irregular shape of obstacles.*

#### f. Doors

##### (i) Emergency Exit Symbol

Directional Sign for identifying doors leading to an emergency exit consisting of materials and manufactured using processes as defined in section 2.02 (iv).

##### (ii) Door Hardware Markings

Door Handle Marker consisting of materials and manufactured using processes as defined in section 2.02 (iv).

**EXCEPTION:** For rounded push bars non-HTC products may be used and may consist of high quality vinyl.

## Best Practice Specification

### (iii) Door Frame Markings

Guidance Strip for marking flat handrails consisting of materials and manufactured using processes as defined in section 2.02.

### 2.04 Performance Criteria

All HTC products to meet or exceed the performance criteria specified in the following tests or standards. PC = Performance Criteria

#### a. Slip Resistance

AS/NZS 4586-2004, Slip Resistance Classification of New Pedestrian Surface Materials. PC – Dry slip resistance classification F, wet slip resistance classification V, slip resistance assessment group R12. AS 4586-2013 PC – Classification: P5

#### b. UV Resistance

ASTM G155-04 Cycle 1 1000hrs, Standard Practice for Operating Xenon Arc Light Apparatus for Exposure of Nonmetallic Materials.

PC – Loss in luminance after exposure < 10%

#### c. Salt Spray Resistance

ASTM B117-97 Standard Practice for Operating Salt Spray (Fog) Apparatus. PC – Slight corrosion build up along scribes, no blistering or filiform growth along scribes.

#### d. Washability

ASTM D4828-94(2003), Standard Test Methods for Practical Washability of Organic Coatings.

PC – crayon, pen, 3M soil: all rating 10, being complete removal of soilant.

#### e. Rate of Burning

ASTM D635-03, Standard Test Method for Rate of Burning and/or Extent and Time of Burning of Plastics in a Horizontal Position.

PC – Time of burn 0 seconds, does not burn.

#### f. Surface Flammability

ASTM E162-02, Standard Test Method for Surface Flammability of Materials Using a Radiant Heat Energy Source.

PC – Flame spread index 7.6, ignites with difficulty.

#### g. Toxicity

Bombardier Toxic Gas Generation Test SMP800-C.

PC - Pass

#### h. Radioactivity

ASTM D3648-2004, Standard Practices for the Measurement of Radioactivity.

PC – Pass

#### i. Luminance

UL 1994 Standard for Luminous Egress Path Marking Systems.

PC – Pass

#### j. High Temperature Curing

Independently tested by placing 3 samples in an oven at 150°C for 20 minutes and then examining the samples after removing from the oven.

PC – the samples shall have no shrinkage, delamination, distortion, or yellowing.

## Part 3 CONSTRUCTION REQUIREMENTS

### 3.01 Manufacturer's Instructions

Comply with manufacturer's product data, installation instructions and maintenance and cleaning instructions.

### 3.02 Examination

Site verification of conditions is required to verify installation surface and appropriate installation method.

### 3.03 Installation

Installation must be as per manufacturer's installation instructions.

### 3.05 Cleaning

Maintenance and cleaning should be carried out as per manufacturer's maintenance and cleaning instructions.

## Part 4 METHOD OF MEASUREMENT

### 4.01 Accepted Quantity of Products

Egress path marking products shall be measured by the standard unit, or part-there-of, to determine the accepted quantity.

## Part 5 BASIS OF PAYMENT

### 5.01 Contract Unit Price

The accepted quantities, as determined in Part 4 Method of Measurement, shall be paid at the contract unit prices plus any % loading for customisation of lengths.

## Best Practice Specification

### Part 1 DESCRIPTION

#### 1.01 System Description

Approved photoluminescent fire protection signs shall communicate fire protection information and shall be readily visible in all conditions of foreseeable use, including emergency conditions and darkness, and shall be provided as required in buildings by relevant building code.

#### 1.02 Photoluminescent Fire Protection Signs

Photoluminescent fire protection signs shall be provided to provide information relating to hazards, fire equipment, warnings and general direction of travel.

#### 1.03 Approved Photoluminescent Fire Protection Signs

Approved photoluminescent fire protection signs shall:

- (a) Exceed PSPA class D classification and have independent luminance testing to support the minimum luminance levels detailed in following clause 2.04(h); **and**
- (b) Be produced using a High Temperature Curing (HTC) manufacturing process and independently tested to support the criteria detailed in following clause 2.04i. **and**
- (c) Be produced by a manufacturer with ISO 9001 Quality Assurance certification; **and**
- (d) Be warranted to last a minimum of 30 years indoors.

#### 1.04 Submittals

Documentation as detailed in 1.04a. through 1.04c. must be submitted.

##### a. Manufacturer's Product Data Sheets

Submit Product Data Sheets for product number verification.

##### b. Manufacturer's Installation Instructions

Submit installation instructions.

##### c. Test Reports

Submit independent test reports to verify compliance with relevant standards as detailed in Section 2.04 Performance Criteria.

#### 1.05 Quality Assurance

Submit copy of Manufacturer's ISO 9001 Quality Assurance documentation.

#### 1.06 Warranty

Submit warranty for luminance characteristics for a minimum 30 years of indoor use.

### Part 2 MATERIALS REQUIREMENTS

#### 2.01 Photoluminescent fire protection signs

##### a. Acceptable Manufacturer

The manufacturer of the products shall have at least 20 years experience manufacturing photoluminescent materials.

##### b. Authorised Representative

The manufacturer shall have a suitably trained and accredited regional based representative.

#### 2.02 Materials Composition

##### a. Photoluminescent Fire Protection Signs

Photoluminescent pigment embedded in thermoset polyester manufactured using a High Temperature Curing (HTC) process at a temperature exceeding 160°C to integrally bond the active ingredients to 5005 0.9mm aluminium sheet.

#### 2.03 Approved Fire Protection Signs

Fire protection signs for communicating fire protection information shall consist of materials and be manufactured using processes as defined in section 2.02.

#### 2.04 Performance Criteria

All HTC products to meet or exceed the performance criteria specified in the following tests or standards. PC = Performance Criteria.

##### a. UV Resistance

ASTM G155-04 Cycle 1 1000hrs, Standard Practice for Operating Xenon Arc Light Apparatus for Exposure of Non-metallic Materials.

PC – Loss in luminance after exposure < 10%

##### b. Salt Spray Resistance

ASTM B117-97 Standard Practice for Operating Salt Spray (Fog) Apparatus.

PC – Slight corrosion build up along scribes, no blistering or filiform growth along scribes.

##### c. Washability

ASTM D4828-94(2003), Standard Test Methods for Practical Washability of Organic Coatings.

PC – crayon, pen, 3M soil: all rating 10, being complete removal of soilant.

##### d. Rate of Burning

ASTM D635-03, Standard Test Method for Rate of Burning and/or Extent and Time of Burning of Plastics in a Horizontal Position.

PC – Time of burn 0 seconds, does not burn.

## Best Practice Specification

### e. Surface Flammability

ASTM E162-02, Standard Test Method for Surface Flammability of Materials Using a Radiant Heat Energy Source.

PC – Flame spread index 7.6, ignites with difficulty.

### f. Toxicity

Bombardier Toxic Gas Generation Test SMP800-C.

PC - Pass

### g. Radioactivity

ASTM D3648-2004, Standard Practices for the Measurement of Radioactivity.

PC – Pass

### h. Luminance

Independent luminance testing shall be undertaken as follows:

Excitation Condition (charging) – 150W Xenon lamp, 1000 lux for 5 minutes.

PC – Minimum luminance of:

2,000 mcd/m<sup>2</sup> after 2 minutes; **and**

400 mcd/m<sup>2</sup> after 10 minutes; **and**

100 mcd/m<sup>2</sup> after 30 minutes; **and**

50 mcd/m<sup>2</sup> after 60 minutes; **and**

20 mcd/m<sup>2</sup> after 120 minutes.

### i. High Temperature Curing

Independently tested by placing 3 samples in an oven at 150°C for 20 minutes and then examining the samples after removing from the oven.

PC – the samples shall have no shrinkage, delamination, distortion, or yellowing.

## Part 3 CONSTRUCTION REQUIREMENTS

### 3.01 Manufacturer's Instructions

Comply with manufacturer's product data, installation instructions and maintenance and cleaning instructions.

### 3.02 Examination

Site verification of conditions is required to verify installation surface and appropriate installation method.

### 3.03 Installation

Installation must be as per manufacturer's installation instructions.

### 3.05 Cleaning

Maintenance and cleaning should be carried out as per manufacturer's maintenance and cleaning instructions.

## Part 4 METHOD OF MEASUREMENT

### 4.01 Accepted Quantity of Signs

Photoluminescent fire protection signs shall be measured by the unit to determine the accepted quantity.

### 4.02 Accepted Quantity of Brackets

Brackets shall be measured by the unit to determine the accepted quantity.

## Part 5 BASIS OF PAYMENT

### 5.01 Contract Unit Price

The accepted quantities, as determined in Part 4 Method of Measurement, shall be paid at the contract unit prices.

## Best Practice Specification

### Part 1 DESCRIPTION

#### 1.01 System Description

Approved photoluminescent disaster preparedness signs shall communicate disaster preparedness information and shall be readily visible in all conditions of foreseeable use, including emergency conditions and darkness.

#### 1.02 Photoluminescent Disaster Preparedness Signs

Photoluminescent disaster preparedness signs shall be provided to provide information relating to disaster mitigation, hazards and general direction of evacuation.

#### 1.03 Approved Photoluminescent Disaster Preparedness Signs

Approved photoluminescent disaster preparedness signs shall:

- (a) Exceed PSPA class G classification and have independent luminance testing to support the minimum luminance levels detailed in following clause 2.04(h); **and**
- (b) Be produced using a High Temperature Curing (HTC) manufacturing process and independently tested to support the criteria detailed in following clause 2.04i. **and**
- (c) Be coated with a clear protective powder coating; **and**
- (d) Be produced by a manufacturer with ISO 9001 Quality Assurance certification; **and**
- (e) Be warranted to last a minimum of 15 years outdoors.

#### 1.04 Submittals

Documentation as detailed in 1.04a. through 1.04c. must be submitted.

##### a. Manufacturer's Product Data Sheets

Submit Product Data Sheets for product number verification.

##### b. Manufacturer's Installation Instructions

Submit installation instructions.

##### c. Test Reports

Submit independent test reports to verify compliance with relevant standards as detailed in Section 2.04 Performance Criteria.

#### 1.05 Quality Assurance

Submit copy of Manufacturer's ISO 9001 Quality Assurance documentation.

#### 1.06 Warranty

Submit warranty for luminance characteristics for a minimum 15 years of outdoor use.

### Part 2 MATERIALS REQUIREMENTS

#### 2.01 Photoluminescent disaster preparedness signs

##### a. Acceptable Manufacturer

The manufacturer of the products shall have at least 20 years experience manufacturing photoluminescent materials.

##### b. Authorised Representative

The manufacturer shall have a suitably trained and accredited regional based representative.

#### 2.02 Materials Composition

##### a. Photoluminescent Disaster Preparedness Signs

Photoluminescent pigment embedded in thermoset polyester manufactured using a High Temperature Curing (HTC) process at a temperature exceeding 160°C to integrally bond the active ingredients to 5005 0.9mm aluminium sheet.

#### 2.03 Approved Disaster Preparedness Signs

Disaster preparedness signs for communicating disaster preparedness information shall consist of materials and be manufactured using processes as defined in section 2.02.

#### 2.04 Performance Criteria

All HTC products to meet or exceed the performance criteria specified in the following tests or standards. PC = Performance Criteria.

##### a. UV Resistance

ASTM G155-04 Cycle 1 1000hrs, Standard Practice for Operating Xenon Arc Light Apparatus for Exposure of Non-metallic Materials.

PC – Loss in luminance after exposure < 10%

##### b. Salt Spray Resistance

ASTM B117-97 Standard Practice for Operating Salt Spray (Fog) Apparatus.

PC – Slight corrosion build up along scribes, no blistering or filiform growth along scribes.

##### c. Washability

ASTM D4828-94(2003), Standard Test Methods for Practical Washability of Organic Coatings.

PC – crayon, pen, 3M soil: all rating 10, being complete removal of soilant.

## Best Practice Specification

### d. Rate of Burning

ASTM D635-03, Standard Test Method for Rate of Burning and/or Extent and Time of Burning of Plastics in a Horizontal Position.  
PC – Time of burn 0 seconds, does not burn.

### e. Surface Flammability

ASTM E162-02, Standard Test Method for Surface Flammability of Materials Using a Radiant Heat Energy Source.  
PC – Flame spread index 7.6, ignites with difficulty.

### f. Toxicity

Bombardier Toxic Gas Generation Test SMP800-C.  
PC - Pass

### g. Radioactivity

ASTM D3648-2004, Standard Practices for the Measurement of Radioactivity.  
PC – Pass

### h. Luminance

Independent luminance testing shall be undertaken as follows:  
Excitation Condition (charging) – 20W Fluorescent lamp, 5000 lux for 60 minutes.

PC – Minimum luminance of:

- 4,900 mcd/m<sup>2</sup> after 2 minutes; **and**
- 950 mcd/m<sup>2</sup> after 10 minutes; **and**
- 250 mcd/m<sup>2</sup> after 30 minutes; **and**
- 120 mcd/m<sup>2</sup> after 60 minutes; **and**
- 10 mcd/m<sup>2</sup> after 480 minutes.

### i. High Temperature Curing

Independently tested by placing 3 samples in an oven at 150°C for 20 minutes and then examining the samples after removing from the oven.

PC – the samples shall have no shrinkage, delamination, distortion, or yellowing.

## Part 3 CONSTRUCTION REQUIREMENTS

### 3.01 Manufacturer's Instructions

Comply with manufacturer's product data, installation instructions and maintenance and cleaning instructions.

### 3.02 Examination

Site verification of conditions is required to verify installation surface and appropriate installation method.

### 3.03 Installation

Installation must be as per manufacturer's installation instructions.

### 3.05 Cleaning

Maintenance and cleaning should be carried out as per manufacturer's maintenance and cleaning instructions.

## Part 4 METHOD OF MEASUREMENT

### 4.01 Accepted Quantity of Signs

Photoluminescent disaster preparedness signs shall be measured by the unit to determine the accepted quantity.

### 4.02 Accepted Quantity of Brackets

Brackets shall be measured by the unit to determine the accepted quantity.

## Part 5 BASIS OF PAYMENT

### 5.01 Contract Unit Price

The accepted quantities, as determined in Part 4 Method of Measurement, shall be paid at the contract unit prices.

# Master Format Specification Document



## Ecoglo Photoluminescent Egress Path Markings

This specification has been numbered, organized and formatted in accordance with the MasterFormat, Section Format and Page Format documents published jointly by Construction Specifications Institute (CSI). For convenience, all products are contained within Section 10 14 43 (Photoluminescent Egress Path Markings) but if desired may be edited/adapted to suit any other Section(s) of Work in accordance with project requirements.

It is offered as a guide to experienced and knowledgeable construction professionals who assume full responsibility for its interpretation and use. Square brackets [ ] containing text indicate an option to be considered/inserted by the specifier. Remove brackets and unused options before printing.

For a copy of the Master Format Specification document please email [Specification@Ecoglo.com](mailto:Specification@Ecoglo.com)

## Section 10 14 43 Ecoglo Photoluminescent Egress Path Markings

### Part 1 General

#### 1.1 Summary

- A Work Included: Furnishing and installation of complete photoluminescent Egress Path Marking System.
  - 1 Stair and Leading Edge Markings
  - 2 Handrail Markings
  - 3 Perimeter Demarcation and Door Frame Markings
  - 4 Obstacle Markings
  - 5 Stairway/Floor Identification Signs
  - 6 Egress Signage
  - 7 Door Hardware Markings

#### 1.2 Related Sections:

- A Division 01: Administrative, procedural, and temporary work requirements
- B Section 26 5213 - Photoluminescent Exit Signs.
- C Section 05 5500 – Photoluminescent (Metal) Stair Treads and Nosings.

#### 1.3 Design Requirements

- A Photoluminescent Exit Path Marking System shall be a complete system of low level egress markings in compliance with the requirements of the local building code and fire code.
- B Photoluminescent step edge marking products shall provide step edge colour contrast and slip resistance.
  - 1 Photoluminescent material shall be recessed within powder coated aluminium (aluminum) ridges which provide slip resistance and protect the photoluminescent material.
  - 2 Photoluminescent material utilized in step edge markings shall not have an abrasive texture that collects dirt and results in lower photoluminescent performance.
  - 3 Step edge products shall include an integrally bonded silicon carbide abrasive non-slip component that provides colour contrast.
  - 4 Step edge products shall be aluminium (aluminum) based and manufactured using High Temperature Curing (HTC) technology.  
Flexible tape products and vinyl materials are not acceptable.

- C Photoluminescent egress markings shall be 1 inch (25 mm) wide, or UL 1994 listed.
- D Stairway/Floor Identification Signage in high rise buildings requiring photoluminescent egress markings are required to be made of photoluminescent material and must meet the following requirements.
  - 1 Signs shall be a minimum size of 18 inches x 12 inches (460 mm x 310 mm).
  - 2 Include the Identification of Stair
  - 3 Roof Access Yes/No
  - 4 Floor Number
  - 5 Optional: Braille Floor Number
  - 6 Termination top/Bottom of stair
  - 7 Story and direction of exit discharge
- E. Where photoluminescent egress path markings are installed, they shall be provided with not less than 54 lux of illumination for not less than 60 minutes prior to periods when the building is occupied, and continuously during the building occupancy.

#### 1.4 References

- A [National Fire Protection Association (NFPA) 101 - Life Safety Code]
- B [2009 International Building Code / International Fire Code (IBC/IFC) section 1024]  
[2012 International Building Code / International Fire Code (IBC/IFC) section 1024]  
[2015 International Building Code / International Fire Code (IBC/IFC) section 1025]  
[2018 International Building Code / International Fire Code (IBC/IFC) section 1025]
- C [New York City LL 141 Photoluminescent Exit Path Markings section 1024]
- D Underwriters Laboratories, Inc. (UL) UL 1994 Standard for Safety, Luminous Egress Path Marking Systems.
- E American Society for Testing & Materials (ASTM) ASTM E2072, Standard Specification for Photoluminescent (Phosphorescent) Safety Markings and E2073 – Standard Test Method for Photopic Luminance of Photoluminescent (Phosphorescent) Markings.

#### 1.5 Quality Assurance

- A Manufacturer Qualifications: to have minimum of 20 years experience with similar work.
- B Installer Qualifications: to be manufacturer trained/authorized installer.



# Photoluminescent Egress Path Markings

## 1.6 Submittals

- A Submit the following [in accordance with Section 01 33 00 – Submittal Procedures]:
- 1 Product Data: Manufacturer's product data sheets for materials used in system.
  - 2 Shop Drawings: Provide drawings showing details, dimensions, extent of work, and other data necessary for the satisfactory installation of the products stated herein for compliance with the local building code requirements.
  - 3 Samples: 12" size for review showing final colour. Label samples with product codes and intended use.
  - 4 Manufacturer's Instructions: Pre-printed material describing installation of product, system or material, including special notices.
  - 5 Test Reports: Submit independent test reports to verify compliance with relevant standards as detailed in 2.2A(3) and 2.2A(4).
  - 6 Substitutions: Substitutions must be submitted and approved prior to bid date. All requests shall include test results, product descriptions, confirmation of piece design and engineering calculations meeting design criteria.

### Include the following for submission of sustainable design submittals.

- B Sustainable Design Submittals:
- 1 Regional Materials: Certify manufacturing location.
  - 2 Construction Waste Management Divert from Land Fill: Certify if products are made with materials that are recyclable.
  - 3 Recycled Content: Certify percent recycled content and designate whether pre-consumer or post-consumer.
  - 4 VOC content for installation adhesives.

## 1.7 Delivery, Storage and Handling

- A Handle and store Products in a manner to prevent damage, deterioration and soiling to Products, other building components, assemblies, other Products, the structure, the Site and surrounding property and in accordance with manufacturer's instructions.
- B Store products subject to damage from weather in weather proof enclosures.

## 1.8 Warranty

- A Provide manufacturer's limited warranty. Warranty to cover defects in materials and workmanship.
- 1 High Temperature Curing (HTC) Products: (5) years from the date of Substantial Performance of the Work.
  - 2 30 Year Warranty on photoluminescent performance of HTC products when positioned indoors.

## Part 2 Products

### 2.1 Manufacturers

- A Contract Documents are based on products by Ecoglo International Ltd. ([www.ecoglo.com](http://www.ecoglo.com))
- B Substitutions: [Under provisions of Division 01.] Submit for consideration prior to bid closing.

### 2.2 Materials

- A High Temperature Curing (HTC) Products:
- 1 Extruded Aluminium (Aluminum) Nosings: 6060T5 extrusion anodized to Class 1, .0007" (20 microns) thickness.
  - 2 Photoluminescent material: manufactured using HTC technology - strontium aluminate-based photoluminescent pigment embedded in thermoset polyester carriers that integrally bond the active ingredients into powder coated aluminium (aluminum) substrates following curing at 350°F (180°C).
  - 3 Materials shall be UL 1994 listed.
  - 4 All HTC products to meet or exceed the performance criteria specified in the following tests or standards.  
PC = Performance Criteria
    - a. Slip Resistance  
UL 410 Standard for Slip Resistance for Floor Surface Materials, PC – Pass, or alternatively, AS/NZS 4586-2004, Slip Resistance Classification of New Pedestrian Surface Materials. PC – Dry slip resistance classification F, wet slip resistance classification V, slip resistance assessment group R12 AS4586-2013 PC - Classification: P5
    - b. UV Resistance  
ASTM G155-04 Cycle 1 1000hrs, Standard Practice for Operating Xenon Arc Light Apparatus for Exposure of Nonmetallic Materials. PC – Loss in luminance after exposure < 10%

# Photoluminescent Egress Path Markings

## c. Salt Spray Resistance

ASTM B117-97 Standard Practice for Operating Salt Spray (Fog) Apparatus. PC – Slight corrosion build up along scribes, no blistering or filiform growth along scribes.

## d. Washability

ASTM D4828-94(2003), Standard Test Methods for Practical Washability of Organic Coatings. PC – crayon, pen, 3M soil: all rating 10, being complete removal of soilant.

## e. Rate of Burning

ASTM D635-03, Standard Test Method for Rate of Burning and/or Extent and Time of Burning of Plastics in a Horizontal Position. PC – Time of burn 0 seconds, does not burn.

## f. Surface Flammability

ASTM E162-02, Standard Test Method for Surface Flammability of Materials Using a Radiant Heat Energy Source. PC – Flame spread index 7.6, ignites with difficulty.

## g. Toxicity

Bombardier Toxic Gas Generation Test SMP800-C. PC – Pass.

## h. Radioactivity

ASTM D3648-2004, Standard Practices for the Measurement of Radioactivity. PC – Pass.

## i. Luminance

UL 1994 Standard for Luminous Egress Path Marking Systems. PC – Pass.

## j. High Temperature Curing

Independently tested by placing 3 samples in an oven at 150°C for 20 minutes and then examining the samples after removing from the oven. PC – the samples shall have no shrinkage, delamination, distortion, or yellowing.

- 5 Anti-slip surface: manufactured using HTC technology – silicon carbide integrally bonded into powder-coated aluminium (aluminum) substrates following curing at 350°F (180°C).

## 2.3 Components

### A Step Edge Markings

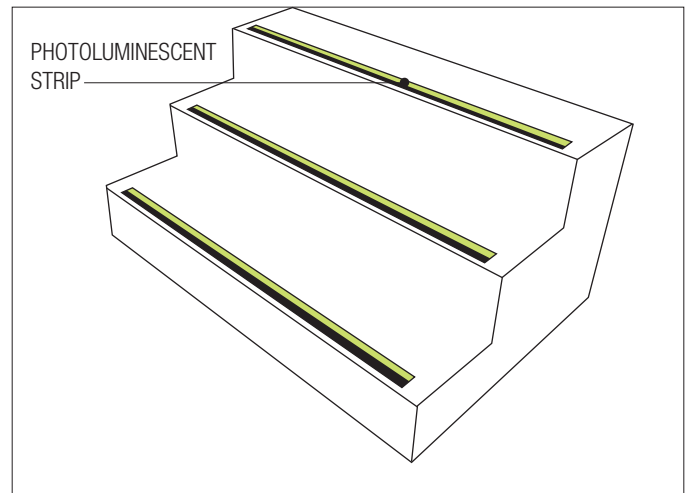

- 1 Step Edge Product Code: [E14-075]

Description: [64mm wide strip incorporating 10mm photoluminescent strip and 50mm black anti-slip strip. Available in lengths from 800mm to 1500mm in 100mm increments, or in full lengths of 2450mm or 3060mm.]

*SPEC NOTE: The listed data included in table below provide product codes and descriptions. Anti-slip in all products is black in colour. Specification articles (product selections) contained within square brackets [ ] are shown as example choices only.*

[Click Here to view Ecoglo Step Edge Products](#)

# Photoluminescent Egress Path Markings

Product Code	Description
F15-175 Step Nosing	75mm x 33mm aluminium (aluminum) nosing incorporating 12.6mm photoluminescent strip and 50mm black anti-slip strip. Available in lengths from 800mm to 1500mm in 100mm increments, or in full lengths of 2450mm or 3060mm.
F14-175 Step Nosing	75mm x 10mm aluminium (aluminum) nosing incorporating 12.6mm photoluminescent strip and 50mm black anti-slip strip. Available in lengths from 800mm to 1500mm in 100mm increments, or in full lengths of 2450mm or 3060mm.
F15-173 Step Nosing	75mm x 33mm aluminium (aluminum) nosing incorporating 25mm photoluminescent strip and 50mm black anti-slip strip. Available in lengths from 800mm to 1500mm in 100mm increments, or in full lengths of 2450mm or 3060mm.
F14-173 Step Nosing	75mm x 10mm aluminium (aluminum) nosing incorporating 25mm photoluminescent strip and 50mm black anti-slip strip. Available in lengths from 800mm to 1500mm in 100mm increments, or in full lengths of 2450mm or 3060mm.
F2-003 Step Nosing	77mm x 22mm aluminium (aluminum) nosing incorporating 26mm photoluminescent strip. Available in lengths from 800mm to 1500mm in 100mm increments, or in full lengths of 2450mm or 3060mm.
E2-071 Step Edge Contrast	37mm wide strip incorporating 16mm photoluminescent strip and 21mm black anti-slip strip. Available in lengths from 800mm to 1500mm in 100mm increments, or in full lengths of 2450mm or 3060mm.
E14-075 Step Edge Contrast	64mm wide strip incorporating 10mm photoluminescent strip and 50mm black anti-slip strip. Available in lengths from 800mm to 1500mm in 100mm increments, or in full lengths of 2450mm or 3060mm.
E15-073 Step Edge Contrast	64mm wide strip incorporating 26mm photoluminescent strip and 25mm black anti-slip strip. Available in lengths from 800mm to 1500mm in 100mm increments, or in full lengths of 2450mm or 3060mm.
E4-073 Step Edge Contrast	51mm wide strip incorporating 26mm photoluminescent strip and 25mm black anti-slip strip. Available in lengths from 800mm to 1500mm in 100mm increments, or in full lengths of 2450mm or 3060mm.
G6-003 Guidance Strip	26mm wide photoluminescent strip suitable for step edging. Available in lengths from 800mm to 1500mm in 100mm increments, and in full length of 3060mm.

# Photoluminescent Egress Path Markings

## B Handrail Markings

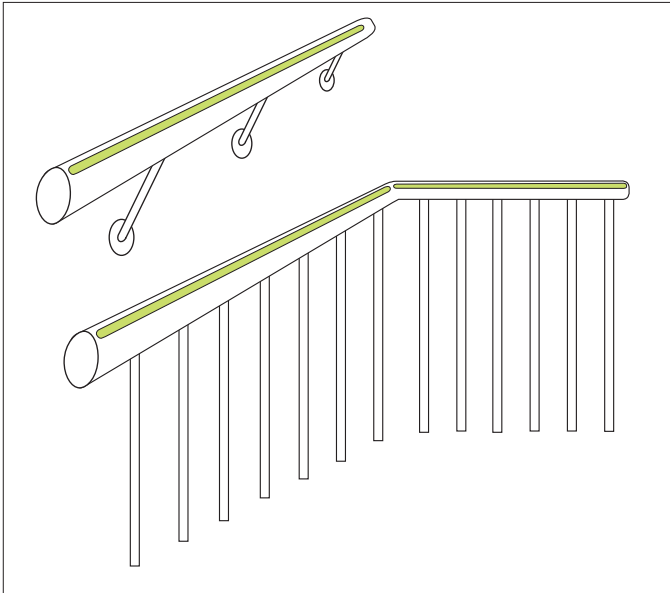

1 Handrail Markings Product Code: [H5-001]

Description: [27mm wide photoluminescent handrail strip suitable for curved handrails.

Available in 1000mm and 3060mm lengths.]

*SPEC NOTE: The listed data included in table below provide product codes and descriptions. Specification articles (product selections) contained within square brackets [ ] are shown as example choices only.*

[Click Here to view Ecoglo Handrail Products](#)

Product Code	Description
H3-001 Handrail Strip	15.5mm wide photoluminescent handrail strip suitable for curved handrails. Available in 1000mm and 3060mm lengths.
HREC3 End Cap	Metal End Cap for use with H3-001
H5-001 Handrail Strip	27mm wide photoluminescent handrail strip suitable for curved handrails. Available in 1000mm and 3060mm lengths.
HEC5 End Cap	Plastic End Cap for use with H5-001
G3-001 Guidance Strip	15.5mm wide photoluminescent strip suitable for flat handrails. Available in 1000mm and 3060mm lengths.
G6-003 Guidance Strip	26mm wide photoluminescent strip suitable for flat handrails. Available in lengths from 800mm to 1500mm in 100mm increments, and in full length of 3060mm.

# Photoluminescent Egress Path Markings

## C Perimeter Demarcation

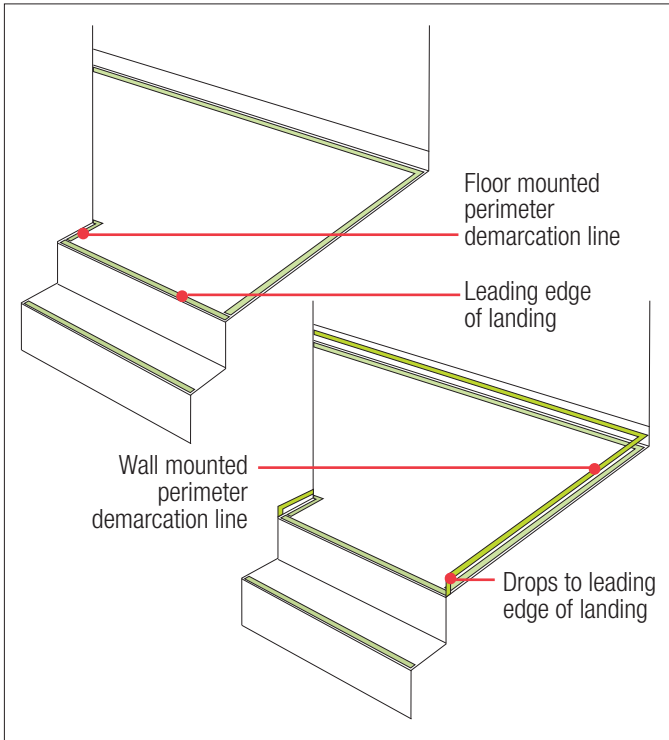

- 1 Perimeter Demarcation Product Code: [G3-001]  
Description: [15.5mm wide photoluminescent strip.  
Available in 1000mm and 3060mm lengths.]

*SPEC NOTE: The listed data included in table below provide product codes and descriptions. Specification articles (product selections) contained within square brackets [ ] are shown as example choices only.*

[Click Here to view Ecoglo Perimeter Demarcation Products](#)

Product Code	Description
G3-001 Guidance Strip	15.5mm wide photoluminescent strip. Available in 1000mm and 3060mm lengths.
G6-003 Guidance Strip	26mm wide photoluminescent strip. Available in lengths from 800mm to 1500mm in 100mm increments, and in full length of 3060mm.
T6-101 Path Marker	37mm wide aluminium extrusion incorporating 15.5mm wide photoluminescent strip. Available in 1000mm lengths.
T5-101 Path Marker	51mm wide aluminium extrusions incorporating 15.5mm wide photoluminescent strip. Available in 1000mm lengths.

# Photoluminescent Egress Path Markings

## D Obstacle Marking

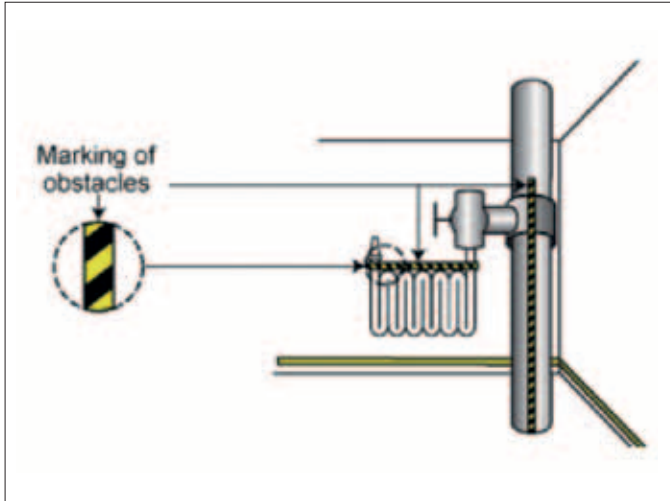

- 1 Obstacle Marking Product Code: UL-HZ2518  
Description: Manufactured from high quality vinyl tape.  
Available in rolls 25mm wide x 18m. (Non-HTC Product)

[Click Here to view Ecoglo Obstruction Marking Products](#)

## E Stairway Identification Signs

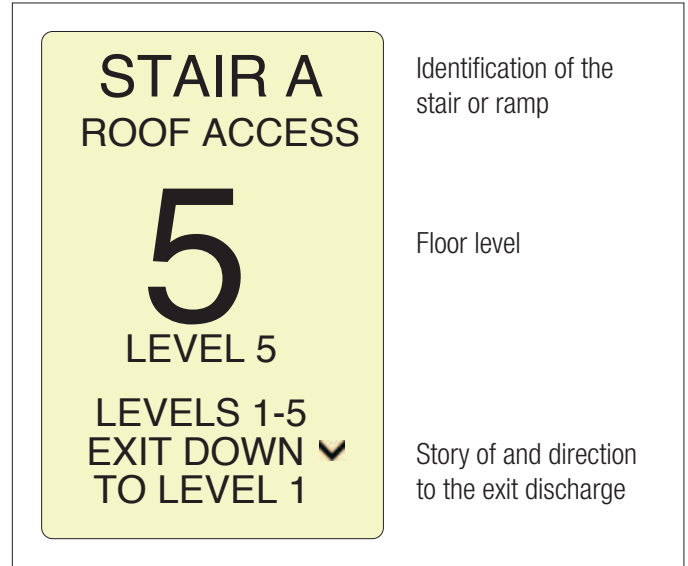

- 1 Stairway Identification Signs Product Code: S5-SI4631  
Description: Photoluminescent Floor Identification Signs. 18" by 12" (460mm x 310mm) with Tactile raised Floor level numbers (ICC A117.1 compliant). Braille floor number optional. Signage shall state the story of, and the direction to, the exit discharge and the availability of roof access from the enclosure for the fire department.

[Click Here to view Ecoglo Stairway Identification Signs](#)

# Photoluminescent Egress Path Markings

## F Photoluminescent Egress Signage

1 Directional egress signage. 100 mm x 100 mm. Signs can be used alone or in combination with other egress signage.

[Click Here to view Ecoglo Egress Signage](#)

Product Code	Description
S5-RML1010	Directional pictogram – left facing. 100mm x 100mm..
S5-RMR1010	Directional pictogram – right facing. 100mm x 100mm
S5-ARS1010	Directional arrow – straight. 100mm x 100mm
S5-ARD1010	Directional arrow – diagonal. 100mm x 100mm

## G Door Hardware Markings

- 1 Door handle marker (100 mm x 100 mm).
- 2 Door Push Bar Marker (407 mm x 38 mm). (Non-HTC product.)

[Click Here to view Ecoglo Door Hardware Markings](#)

Product Code	Description
S5-DHM1010	Door handle marker. 100mm x 100mm
UL-DHM3840	Door push bar marker with 'PUSH TO OPEN' text on photoluminescent background. 470mm x 38mm

# Photoluminescent Egress Path Markings

## Part 3 Execution

### 3.1 Examination

- A Before installation, examine surfaces on which the work of this section depends. Notify [Contractor] if substrates do not comply with requirements of this section.
- B Ensure any painted surfaces are fully cured.
- C Do not proceed with work of this Section until all unsatisfactory conditions have been corrected, if any.
- D Commencement of Work will imply acceptance of surfaces.

### 3.2 Preparation

- A Clean surfaces to remove dirt, dust, grease, oil, loose material, frost, paint, coatings, or other matter that may affect bonding or installation of photoluminescent products.
- B Test substrates for fit with products before using adhesives or mechanical fastening.

### 3.3 Installation

- A Install signs [as per Schedule attached at end of Section] [as indicated in Drawings] [positioned in accordance with [National Fire Protection Association (NFPA) 101 - Life Safety Code] [International Building Code / International Fire Code (IBC/IFC)] [New York City RS6-1 and RS6-1A Photoluminescent Exit Path Markings]].
- B Unless otherwise indicated in the specifications, install Products in accordance with manufacturer's instructions. Obtain written instructions directly from manufacturer.

### 3.4 Cleaning

- A Trim any excess adhesive with a sharp blade.
- B At completion of installation, clean soiled Product surfaces in accordance with manufacturer's instructions.

### 3.5 Waste Management and Disposal

- A Separate waste materials for [reuse] [and] [recycling] at nearest used building materials facility.
- B Divert unused caulking, sealants and adhesive materials from landfill through appropriate disposal procedure listed in safety data sheets (SDS).

### 3.6 Protection

- A Allow 24 hours for adhesive cure with no foot traffic permitted.
- B Protect areas from damage using barriers, markers or temporary signs as required.
- C Do not allow heavy objects to come in contact with installed products.



# Ecoglo



# International Safety Data Sheets

## 1. Identification

### Product Name

Ecoglo UL 924 Flat Panel Signs including: S20-UL-RMR392223-50, S20-UL-RMR480280-75, S20-UL-RML392223-50, S20-UL-RML480280-75, S20-UL-RMUA392223-50, S20-UL-RMUA480280-75, S20-UL-RMDA392223-50, S20-UL-RMDA480280-75, S20-UL-RMDR392223-50, S20-UL-RMDR480280-75, S20-UL-RMDL392223-50, S20-UL-RMDL480280-75, S20-UL-RMUR392223-50, S20-UL-RMUR480280-75, S20-UL-RMUL392223-50, S20-UL-RMUL480280-75, S20-UL-EX353183-50, S20-UL-EX481249-75, S20-UL-EXR353183-50, S20-UL-EXR481249-75, S20-UL-EXL353183-50, S20-EXL481249-75, S20-UL-EXRL353183-50, S20-UL-EXRL481249-75

### Manufacturer Details

**Company:** Ecoglo International Ltd  
**Address:** 77 Kingsley St, Christchurch 8440, New Zealand  
**Phone No:** +64 3 348 3781

## 2. Hazard Identification

Not classified as hazardous or dangerous as per GHS.

## 3. Composition/information on ingredients

Component	CAS No.	Proportion
Aluminium Alloy (5005)	-	40-70%
Strontium Aluminate based photoluminescent pigment	-	10-40%
Cross-linked thermoset polyester based resins	-	10-30%
Other components	-	< 1%

**4. First-aid measures** No special measures required.

**5. Fire-fighting measures** No special measures required.

**6. Accidental release measures** Not applicable.

**7. Handling and storage** Cut edges may be sharp. No special storage requirements.

**8. Exposure controls and personal protection** Wear gloves when handling.

## 9. Physical and chemical properties

Appearance:	Solid sheet material
Odour:	N/A
Melting point:	N/A
Specific gravity:	2.2-2.7 g/cc
Volatile:	N/A
Vapour pressure:	N/A
Vapour density:	N/A
Solubility in water:	Insoluble
Flammability:	Not easily combustible. Passes Bombardier SMP 800-C Toxic gas generation test
Explosivity:	Not explosive

## 10. Stability and reactivity

Hazardous reactions:	None known
Radioactivity:	Not Radioactive

**11. Toxicological information** No toxicological properties.

**12. Ecological information** No ecological hazards.

**13. Disposal considerations** Offcuts can be sent for aluminium recycling.

**14. Transport information** Not restricted.

**15. Regulatory information** None applicable to product.

**16. Any other relevant information** None.

## 1. Identification

### Product Name

Ecoglo S20 Flat Panel Signs including: EX2313-16m, EX2916-24m, RM2916-16m, RM4223-24m, RM5630-32m, RM7038-40m, RM8445-48m, RM2916HV-16m, RM4223HV-24m, RMR2916-16m, RMR4223-24m, RMR5630-32m, RMR7038-40m, RMR8445-48m, RML2916-16m, RML4223-24m, RML5630-32m, RML7038-40m, RML8445-48m, RM1616UN-16m, RM2323UN-24m, RMRL2916-16m, RMRL4223-24m, RMRL-2916HV-16m, RMRL4223HV-24m, EE6128-16m, EE7835-24m, NE4113-16m, AR1313, AR1616-16m, AR2323-24m, SQ-60, AC1616, EXRL310166, EXL310166, EXR310166, EX310166

### Manufacturer Details

**Company:** Ecoglo International Ltd  
**Address:** 77 Kingsley St, Christchurch 8440, New Zealand  
**Phone No:** +64 3 348 3781

## 2. Hazard Identification

Not classified as hazardous or dangerous as per GHS.

## 3. Composition/information on ingredients

Component	CAS No.	Proportion
Aluminium Alloy (5005)	-	40-70%
Strontium Aluminate based photoluminescent pigment	-	10-40%
Cross-linked thermoset polyester based resins	-	10-30%
Other components	-	< 1%

**4. First-aid measures** No special measures required.

**5. Fire-fighting measures** No special measures required.

**6. Accidental release measures** Not applicable.

**7. Handling and storage** Cut edges may be sharp. No special storage requirements.

**8. Exposure controls and personal protection** Wear gloves when handling.

## 9. Physical and chemical properties

Appearance:	Solid sheet material
Odour:	N/A
Melting point:	N/A
Specific gravity:	2.2-2.7 g/cc
Volatile:	N/A
Vapour pressure:	N/A
Vapour density:	N/A
Solubility in water:	Insoluble
Flammability:	Not easily combustible. Passes Bombardier SMP 800-C Toxic gas generation test
Explosivity:	Not explosive

## 10. Stability and reactivity

Hazardous reactions:	None known
Radioactivity:	Not Radioactive

**11. Toxicological information** No toxicological properties.

**12. Ecological information** No ecological hazards.

**13. Disposal considerations** Offcuts can be sent for aluminium recycling.

**14. Transport information** Not restricted.

**15. Regulatory information** None applicable to product.

**16. Any other relevant information** None.

This information is offered in good faith to the best of our current knowledge. No warranty, expressed or implied, regarding the accuracy of this data, the hazards connected with use of the material, or the results to be obtained from the use thereof, is made. Ecoglo International Ltd. assumes no responsibility for damage or injury from the use of this product.

## 1. Identification

### Product Name

Ecoglo S5 Flat Panel Signs including: S5-RML1010, S5-RMR1010, S5-ARS1010, S5-ARD1010, S5-SI4631, S5-DHM1010, S5-EX230120, S5-EX290155, S5-EXR230120, S5-EXR290155, S5-EXL230120, S5-EXL290155, S5-EXRL310166, S5-RMLFE-228102, S5-RMRFE-228102, S5-SU228102, S5-SD228102, S5-FEXT228102, S5-EVAC210297, S5-EVAC216280, S5-EVAC216330, S5-EVAC457610, S5-EVAC610915

### Manufacturer Details

Company: Ecoglo International Ltd  
 Address: 77 Kingsley St, Christchurch 8440, New Zealand  
 Phone No: +64 3 348 3781

## 2. Hazard Identification

Not classified as hazardous or dangerous as per GHS.

## 3. Composition/information on ingredients

Component	CAS No.	Proportion
Aluminium Alloy (5005)	-	70-85%
Strontium Aluminate based photoluminescent pigment	-	5-15%
Cross-linked thermoset polyester based resins	-	10-30%
Other components	-	< 1%

**4. First-aid measures** No special measures required.

**5. Fire-fighting measures** No special measures required.

**6. Accidental release measures** Not applicable.

**7. Handling and storage** Cut edges may be sharp. No special storage requirements.

**8. Exposure controls and personal protection** Wear gloves when handling.

## 9. Physical and chemical properties

Appearance:	Solid sheet material
Odour:	N/A
Melting point:	N/A
Specific gravity:	2.2-2.7 g/cc
Volatile:	N/A
Vapour pressure:	N/A
Vapour density:	N/A
Solubility in water:	Insoluble
Flammability:	Not easily combustible. Passes Bombardier SMP 800-C Toxic gas generation test
Explosivity:	Not explosive

## 10. Stability and reactivity

Hazardous reactions: None known

Radioactivity: Not Radioactive

**11. Toxicological information** No toxicological properties.

**12. Ecological information** No ecological hazards.

**13. Disposal considerations** Offcuts can be sent for aluminium recycling.

**14. Transport information** Not restricted.

**15. Regulatory information** None applicable to product.

**16. Any other relevant information** None.

This information is offered in good faith to the best of our current knowledge. No warranty, expressed or implied, regarding the accuracy of this data, the hazards connected with use of the material, or the results to be obtained from the use thereof, is made. Ecoglo International Ltd. assumes no responsibility for damage or injury from the use of this product.

**1. Identification****Product Name**

Ecoglo Step Edge Contrast including:

E15-073-800, E15-073-900, E15-073-1000, E15-073-1100, E15-073-1200, E15-073-1300, E15-073-1400, E15-073-1500, E15-073-2450, E15-073-3060, E14-075-800, E14-075-900, E14-075-1000, E14-075-1100, E14-075-1200, E14-075-1300, E14-075-1400, E14-075-1500, E14-075-2450, E14-075-3060, E14-075-200, E14-075-400, E2-071-800, E2-071-900, E2-071-1000, E2-071-1100, E2-071-1200, E2-071-1300, E2-071-1400, E2-071-1500, E2-071-2450, E2-071-3060, E3-071-2450, E3-071-3060, E4-073-800, E4-073-900, E4-073-1000, E4-073-1100, E4-073-1200, E4-073-1300, E4-073-1400, E4-073-1500, E4-073-2450, E4-073-3060, E4-053-800, E4-053-900, E4-053-1000, E4-053-1100, E4-053-1200, E4-053-1300, E4-053-1400, E4-053-1500, E4-053-2450, E4-053-3060,

**Manufacturer Details**

Company: Ecoglo International Ltd

Address: 77 Kingsley St, Christchurch 8440, New Zealand

Phone No: +64 3 348 3781

**2. Hazard Identification**

Not classified as hazardous or dangerous as per GHS.

**3. Composition/information on ingredients**

Component	CAS No.	Proportion
Aluminium Alloy (6063)	-	50-80%
Strontium Aluminate based photoluminescent pigment	-	0.5-5%
Cross-linked thermoset polyester based resins	-	10-30%
Silicon Carbide	-	5-20%
Other components	-	< 0.5%

**4. First-aid measures** No special measures required.

**5. Fire-fighting measures** No special measures required.

**6. Accidental release measures** Not applicable.

**7. Handling and storage** Cut edges may be sharp. No special storage requirements.

**8. Exposure controls and personal protection** Wear gloves when handling.

**9. Physical and chemical properties**

Appearance: Solid Strip material

Odour: N/A

Melting point: N/A

Specific gravity: 2.2-2.7 g/cc

Volatile: N/A

Vapour pressure: N/A

Vapour density: N/A

Solubility in water: Insoluble

Flammability: Not easily combustible. Passes Bombardier SMP 800-C Toxic gas generation test

Explosivity: Not explosive

**10. Stability and reactivity**

Hazardous reactions: None known

Radioactivity: Not Radioactive

**11. Toxicological information** No toxicological properties.

**12. Ecological information** No ecological hazards.

**13. Disposal considerations** Offcuts can be sent for aluminium recycling.

**14. Transport information** Not restricted.

**15. Regulatory information** None applicable to product.

**16. Any other relevant information** None.

This information is offered in good faith to the best of our current knowledge. No warranty, expressed or implied, regarding the accuracy of this data, the hazards connected with use of the material, or the results to be obtained from the use thereof, is made. Ecoglo International Ltd. assumes no responsibility for damage or injury from the use of this product.

## 1. Identification

### Product Name

Ecoglo Step Nosings and Path Markers including:

F2-003-800, F2-003-900, F2-003-1000, F2-003-1100, F2-003-1200, F2-003-1300, F2-003-1400, F2-003-1500, F2-003-2450, F2-003-3060, F4-171-800, F4-171-900, F4-171-1000, F4-171-1100, F4-171-1200, F4-171-1300, F4-171-1400, F4-171-1500, F4-171-2450, F4-171-3060, F4-151-800, F4-151-900, F4-151-1000, F4-151-1100, F4-151-1200, F4-151-1300, F4-151-1400, F4-151-1500, F4-151-2450, F4-151-3060, F14-175-800, F14-175-900, F14-175-1000, F14-175-1100, F14-175-1200, F14-175-1300, F14-175-1400, F14-175-1500, F14-175-2450, F14-175-3060, F14-155-800, F14-155-900, F14-155-1000, F14-155-1100, F14-155-1200, F14-155-1300, F14-155-1400, F14-155-1500, F14,155,2450, F14-155-3060, F15-175-800, F15-175-900, F15-175-1000, F15-175-1100, F15-175-1200, F15-175-1300, F15-175-1400, F15-175-1500, F15-175-2450, F15-175-3060, F15-155-800, F15,155, 900, F15-155-1000, F15-155-1100, F15-155-1200, F15-155-1300, F15-155-1400, F15-155-1500, F15-155-2450, F15-155-3060, F14-173-800, F14-173-900, F14-173-1000, F14-173-1100, F14-173-1200, F14-173-1300, F14-173-1400, F14-173-1500, F14-173-2450, F14-173-3060, F15-173-800, F15-173-900, F15-173-1000, F15-173-1100, F15-173-1200, F15-173-1300, F15-173-1400, F15-173-1500, F15-173-2450, F15-173-3060 G7-100, G7-3060, T5-101-1000, T5-101-3060, T6-101-1000, T6-101-3060

### Manufacturer Details

**Company:** Ecoglo International Ltd

**Address:** 77 Kingsley St, Christchurch 8440, New Zealand

**Phone No:** +64 3 348 3781

## 2. Hazard Identification

Not classified as hazardous or dangerous as per GHS.

## 3. Composition/information on ingredients

Component	CAS No.	Proportion
Aluminium Alloy (6063)	-	70-98%
Strontium Aluminate based photoluminescent pigment	-	0.5-15%
Cross-linked thermoset polyester based resins	-	2-20%
Silicon Carbide	-	0-5%
Other components	-	< 3.4%

**4. First-aid measures** No special measures required.

**5. Fire-fighting measures** No special measures required.

**6. Accidental release measures** Not applicable.

**7. Handling and storage** Cut edges may be sharp. No special storage requirements.

**8. Exposure controls and personal protection** Wear gloves when handling.

## 9. Physical and chemical properties

Appearance:	Solid Strip material
Odour:	N/A
Melting point:	N/A
Specific gravity:	2.2-2.7 g/cc
Volatile:	N/A
Vapour pressure:	N/A
Vapour density:	N/A
Solubility in water:	Insoluble
Flammability:	Not easily combustible. Passes Bombardier SMP 800-C Toxic gas generation test
Explosivity:	Not explosive

## 10. Stability and reactivity

Hazardous reactions: None known

Radioactivity: Not Radioactive

**11. Toxicological information** No toxicological properties.

**12. Ecological information** No ecological hazards.

**13. Disposal considerations** Offcuts can be sent for aluminium recycling.

**14. Transport information** Not restricted.

**15. Regulatory information** None applicable to product.

**16. Any other relevant information** None.

This information is offered in good faith to the best of our current knowledge. No warranty, expressed or implied, regarding the accuracy of this data, the hazards connected with use of the material, or the results to be obtained from the use thereof, is made. Ecoglo International Ltd. assumes no responsibility for damage or injury from the use of this product.

## 1. Identification

### Product Name

Ecoglo Guidance Strips, Handrail Markers, and Step Edge Markers including: MS-26-1000, MS-26-3060, G3-001-1000, G3-001-1500, G3-001-3060, G6-003-800, G6-003-900, G6-003-1000, G6-003-1100, G6-003-1200, G6-003-1300, G6-003-1400, G6-003-1500, G6-003-3060, G6-011-300, G6-011-600, G6-011-2450, G6-011-3060, H3-001-1000, H3-001-1500, H3-001-3060, H5-001-1000, H5-001-3060

### Manufacturer Details

**Company:** Ecoglo International Ltd  
**Address:** 77 Kingsley St, Christchurch 8440, New Zealand  
**Phone No:** +64 3 348 3781

## 2. Hazard Identification

Not classified as hazardous or dangerous as per GHS.

## 3. Composition/information on ingredients

Component	CAS No.	Proportion
Aluminium Alloy (6063)	-	60-80%
Strontium Aluminate based photoluminescent pigment	-	2-15%
Cross-linked thermoset polyester based resins	-	10-30%
Other components	-	<0.2%

**4. First-aid measures** No special measures required.

**5. Fire-fighting measures** No special measures required.

**6. Accidental release measures** Not applicable

**7. Handling and storage** Cut edges may be sharp. No special storage requirements.

**8. Exposure controls and personal protection** Wear gloves when handling.

## 9. Physical and chemical properties

Appearance:	Solid Strip material
Odour:	N/A
Melting point:	N/A
Specific gravity:	2.2-2.7 g/cc
Volatile:	N/A
Vapour pressure:	N/A
Vapour density:	N/A
Solubility in water:	Insoluble
Flammability:	Not easily combustible. Passes Bombardier SMP 800-C Toxic gas generation test
Explosivity:	Not explosive

## 10. Stability and reactivity

Hazardous reactions:	None known
Radioactivity:	Not Radioactive

**11. Toxicological information** No toxicological properties.

**12. Ecological information** No ecological hazards.

**13. Disposal considerations** Offcuts can be sent for aluminium recycling

**14. Transport information** Not restricted.

**15. Regulatory information** None applicable to product.

**16. Any other relevant information** None.

This information is offered in good faith to the best of our current knowledge. No warranty, expressed or implied, regarding the accuracy of this data, the hazards connected with use of the material, or the results to be obtained from the use thereof, is made. Ecoglo International Ltd. assumes no responsibility for damage or injury from the use of this product.

## 1. Identification

### Product Name

Ecoglo S20 Disaster Preparedness Flat Panel Signs including: WDG, TEL315155, TER315155, TE315155, EA315290, EA588475, EA950588, EA1190980, EA2380980, EAL315290, EAL588475, EAL950588, EAL1190980, EAL2380980, EAR315290, EAR588475, EAR950588, EAR1190980, EAR2380980, LS315290, LS588475, LS950588, LS1190980, LS2380980, HZ315290, HZ588475, HZ950588, HZ1190980, HZ2380980

### Manufacturer Details

**Company:** Ecoglo International Ltd  
**Address:** 77 Kingsley St, Christchurch 8440, New Zealand  
**Phone No:** +64 3 348 3781

## 2. Hazard Identification

Not classified as hazardous or dangerous as per GHS.

## 3. Composition/information on ingredients

Component	CAS No.	Proportion
Aluminium Alloy (5005)	-	40-70%
Strontium Aluminate based photoluminescent pigment	-	10-40%
Cross-linked thermoset polyester based resins	-	10-30%
Other components	-	< 1%

**4. First-aid measures** No special measures required.

**5. Fire-fighting measures** No special measures required.

**6. Accidental release measures** Not applicable.

**7. Handling and storage** Cut edges may be sharp. No special storage requirements.

**8. Exposure controls and personal protection** Wear gloves when handling.

## 9. Physical and chemical properties

Appearance:	Solid sheet material
Odour:	N/A
Melting point:	N/A
Specific gravity:	2.2-2.7 g/cc
Volatile:	N/A
Vapour pressure:	N/A
Vapour density:	N/A
Solubility in water:	Insoluble
Flammability:	Not easily combustible. Passes Bombardier SMP 800-C Toxic gas generation test
Explosivity:	Not explosive

## 10. Stability and reactivity

Hazardous reactions:	None known
Radioactivity:	Not Radioactive

**11. Toxicological information** No toxicological properties.

**12. Ecological information** No ecological hazards.

**13. Disposal considerations** Offcuts can be sent for aluminium recycling.

**14. Transport information** Not restricted.

**15. Regulatory information** None applicable to product.

**16. Any other relevant information** None.

This information is offered in good faith to the best of our current knowledge. No warranty, expressed or implied, regarding the accuracy of this data, the hazards connected with use of the material, or the results to be obtained from the use thereof, is made. Ecoglo International Ltd. assumes no responsibility for damage or injury from the use of this product.



# Ecoglo Maintenance and Cleaning

Exit Signs and Escape Path Markings

# Maintenance and Cleaning Instructions For Exit Signs and Escape Path Markings

## Overview

- Regular maintenance and cleaning to remove any obstructions or built up dirt and deposits will ensure the Ecoglo products continue performing to expectation.
- The photoluminescence will continue performing even after UV exposure or exposure to moisture.

## Floor Mounted Products

- Check nothing is covering up the product.
- Visually inspect for any sign of damage.
- Vacuuming or brushing with a stiff bristle head brush (dry or wet) is often enough to keep the strips clean.
- The glowing strip can also be wiped clean with a (dry or wet) sponge or cloth.
- High-pressure water (but not steam cleaning) can also be used.
- Observation will determine if cleaning is required however a regular clean every 4 to 6 weeks or after particularly heavy use should ensure correct performance.

## Wall Mounted Products

- Check nothing is covering up the sign.
- Visually inspect for any sign of damage.
- Dusting with a soft cloth or brush is often enough to keep the signs clean.
- The glowing material can also be wiped clean with a (dry or wet) sponge or cloth.
- Observation will determine if cleaning is required.

## Note

- Do not use highly alkaline or acidic cleaning agents. The pH of the cleaning agents should be between pH 5 and pH 12.
- If cleaning agents are applied at more than pH 10, the Ecoglo material should be rinsed with pH neutral (pH 6 to pH 8) solution afterwards.

*For more detailed information re inspection and maintenance procedures for signs please see Photoluminescent Lighting Council Standard PLCS 101 2019, Part C - Inspection and Maintenance (available for download from the Homepage at [www.plcouncil.com.au](http://www.plcouncil.com.au))*



**International**  
**Product Catalogue**  
**Hong Kong Edition**

**Hong Kong Ecoglo**  
hksales@hkecoglo.com  
[www.hongkongecoglo.com](http://www.hongkongecoglo.com)