

Ecoglo International Limited

Technical Manual
for
Photoluminescent Emergency Visibility



Contents:

Photoluminescent Emergency Visibility MasterFormat Specification.....	3
Appendices.....	14



Section 10 45 00

Ecoglo Photoluminescent Emergency Visibility
- primary emergency visibility systems

This specification has been numbered, organized and formatted in accordance with the MasterFormat, Section Format and Page Format documents published jointly by Construction Specifications Institute (CSI). For convenience, all products are contained within Section 10 45 00 (Photoluminescent Emergency Visibility) but if desired may be edited/adapted to suit any other Section(s) of Work in accordance with project requirements.

It is offered as a guide to experienced and knowledgeable construction professionals who assume full responsibility for its interpretation and use.

Square brackets [] containing text indicate an option to be considered/inserted by the specifier. Remove brackets and unused options before printing.

Section 10 45 00

Photoluminescent Emergency Visibility
- primary emergency visibility systems

Part 1 General

- 1.1 Summary
 - A Work Included: Furnishing and installation of complete photoluminescent Emergency Visibility System.
 - 1 Stair and Leading Edge Markings
 - 2 Handrail Markings
 - 3 Perimeter Demarcation and Door Frame Markings
 - 4 Obstacle Markings
 - 6 Egress Signage
 - 7 Door Hardware Markings
- 1.2 Related Sections:
 - A Division 01: Administrative, procedural, and temporary work requirements.
 - B Section 26 5213 - Photoluminescent Exit Signs.
 - C Section 05 5500 – Photoluminescent (Metal) Stair Treads and Nosings.
 - D Section 10 1443 – Photoluminescent Egress Path Marking.
- 1.3 Design Requirements
 - A Photoluminescent Emergency Visibility System shall be a complete emergency visibility system in compliance with the performance requirements of the local building code and fire code.
 - B Photoluminescent step edge marking products shall provide step edge colour contrast and slip resistance.
 - 1 Photoluminescent material in step edge marking shall be recessed within powder coated aluminium (aluminum) ridges which provide slip resistance and protect the photoluminescent material.
 - 2 Photoluminescent material utilized in step edge markings shall not have an abrasive texture that collects dirt and results in lower photoluminescent performance.
 - 3 Step edge products shall include an integrally bonded silicon carbide abrasive non-slip component that provides colour contrast.
 - 4 Step edge products shall be aluminium (aluminum) based and manufactured using High Temperature Curing (HTC) technology. Flexible tape products and vinyl materials are not acceptable for step edge marking.
 - C Photoluminescent egress markings shall be UL 1994 listed.
 - D Where photoluminescent egress path markings are installed, they shall be provided with not less than 54 lux of illumination for not less than 60 minutes prior to periods when the building is occupied, and continuously during the building occupancy.

- 1.4 References
 - A Underwriters Laboratories, Inc. (UL) UL 1994 Standard for Safety, Luminous Egress Path Marking Systems.

- 1.5 Quality Assurance
 - A Manufacturer Qualifications: to have minimum of 20 years' experience with similar work.
 - B Installer Qualifications: to be manufacturer trained/authorized installer.

- 1.6 Submittals
 - A Submit the following [in accordance with Section 01 33 00 – Submittal Procedures]:
 - 1 Product Data: Manufacturer's product data sheets for materials used in system.
 - 2 Shop Drawings: Provide drawings showing details, dimensions, extent of work, and other data necessary for the satisfactory installation of the products stated herein for compliance with the local building code requirements.
 - 3 Samples: 300mm size for review showing final colour. Label samples with product codes and intended use.
 - 4 Manufacturer's Instructions: Pre-printed material describing installation of product, system or material, including special notices.
 - 5 Test Reports: Submit independent test reports to verify compliance with relevant standards as detailed in 2.2A(3) and 2.2A(4).
 - 6 Substitutions: Substitutions must be submitted and approved prior to bid date. All requests shall include test results, product descriptions, confirmation of piece design and engineering calculations meeting design criteria.

Include the following for submission of sustainable design submittals.

- B Sustainable Design Submittals:
 - 1 Regional Materials: Certify manufacturing location.
 - 2 Construction Waste Management Divert from Land Fill: Certify if products are made with materials that are recyclable.
 - 3 Recycled Content: Certify percent recycled content and designate whether pre-consumer or post-consumer.
 - 4 VOC content for installation adhesives.

- 1.7 Delivery, Storage and Handling
 - A Handle and store Products in a manner to prevent damage, deterioration and soiling to Products, other building components, assemblies, other Products, the structure, the Site and surrounding property and in accordance with manufacturer's instructions.
 - B Store products subject to damage from weather in weatherproof enclosures.

1.8 Warranty

- A Provide manufacturer's limited warranty. Warranty to cover defects in materials and workmanship.
 - 1 High Temperature Curing (HTC) Products: (5) years from the date of delivery of the products
 - 2 30 Year Warranty on photoluminescent performance of HTC products when positioned indoors.
 - 3 3 Year Warranty on photoluminescent performance of non-HTC products when positioned indoors.

Part 2 Products

2.1 Manufacturers

- A Contract Documents are based on products by Ecoglo International Ltd. (www.ecoglo.com)
- B Substitutions: [Under provisions of Division 01.] Submit for consideration prior to bid closing.

2.2 Materials

- A High Temperature Curing (HTC) Products
 - 1 Extruded Aluminium (Aluminum) Nosings: 6060T5 extrusion anodized to Class 1, 20 microns thickness.
 - 2 Photoluminescent material: manufactured using HTC technology - strontium aluminate-based photoluminescent pigment embedded in thermoset polyester carriers that integrally bond the active ingredients into powder coated aluminium (aluminum) substrates following curing at 180°C.
 - 3 Materials shall be UL 1994 listed.
 - 4 All HTC products to meet or exceed the performance criteria specified in the following tests or standards. PC = Performance Criteria
 - a. Slip Resistance
 - UL 410 Standard for Slip Resistance for Floor Surface Materials, PC – Pass, or alternatively, AS 4586-2013 Slip Resistance Classification of New Pedestrian Surface Materials. PC - Classification: P5, or AS/NZS 4586-2004, Slip Resistance Classification of New Pedestrian Surface Materials. PC – Dry slip resistance classification F, wet slip resistance classification V, slip resistance assessment group R12
 - b. UV Resistance
 - ASTM G155-04 Cycle 1 1000hrs, Standard Practice for Operating Xenon Arc Light Apparatus for Exposure of Nonmetallic Materials. PC – Loss in luminance after exposure < 10%
 - c. Salt Spray Resistance
 - ASTM B117-97, Standard Practice for Operating Salt Spray (Fog) Apparatus. PC – Slight corrosion build up along scribes, no blistering or filiform growth along scribes.
 - d. Washability
 - ASTM D4828-94 (2003), Standard Test Methods for

- Practical Washability of Organic Coatings. PC – crayon, pen, 3M soil: all rating 10, being complete removal of soilant.
- e. Rate of Burning
ASTM D635-03, Standard Test Method for Rate of Burning and/or Extent and Time of Burning of Plastics in a Horizontal Position. PC – Time of burn 0 seconds, does not burn.
 - f. Surface Flammability
ASTM E162-02, Standard Test Method for Surface Flammability of Materials Using a Radiant Heat Energy Source. PC – Flame spread index 7.6, ignites with difficulty.
 - g. Toxicity
Bombardier Toxic Gas Generation Test SMP800-C.
PC – Pass.
 - h. Radioactivity
ASTM D3648-2004, Standard Practices for the Measurement of Radioactivity. PC – Pass.
 - i. Luminance
UL 1994 Standard for Luminous Egress Path Marking Systems. PC – Pass. AND
All step edge products, handrail markings and perimeter demarcation products shall be independently tested in accordance with UL 1994 except that the observation test is replaced by luminance readings at 60, 90, 120 and 180 minutes after charging ceases. PC -
60 minutes after charging ceases, a minimum of 15 mcd/m²;
and
90 minutes after charging ceases, a minimum of 10 mcd/m²;
and
120 minutes after charging ceases, a minimum of 8 mcd/m²;
and
180 minutes after charging ceases, a minimum of 5 mcd/m².
 - j. High Temperature Curing
Independently tested by placing 3 samples in an oven at 150°C for 20 minutes and then examining the samples after removing from the oven. PC – the samples shall have no shrinkage, delamination, distortion, or yellowing.
- 5 Anti-slip surface: manufactured using HTC technology – silicon carbide integrally bonded into powder-coated aluminium (aluminum) substrates following curing at 180°C.

2.3 Components

A Step Edge Markings

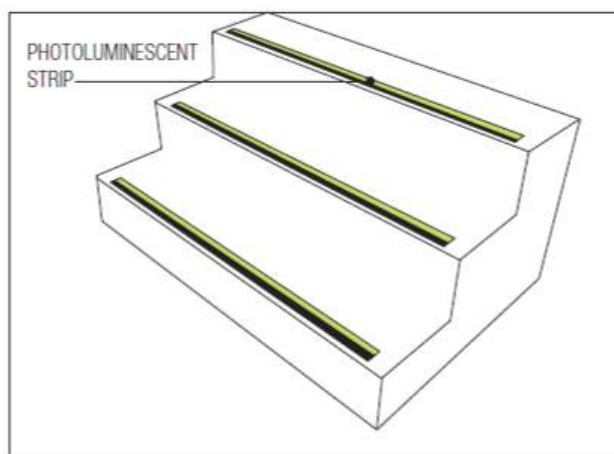

- 1 Step Edge Product Code: [E14-075]
Description: [64mm wide aluminium (aluminum) base strip incorporating 10mm photoluminescent strip and 50mm black anti-slip strip. Available in lengths from 800mm to 1500mm in 100mm increments, or in full lengths of 2450mm or 3060mm.]

SPEC NOTE: The listed data included in table below provide product codes and descriptions. Anti-slip in all products is black in colour. Specification articles (product selections) contained within square brackets [] are shown as example choices only.

[Click Here](#) to view Ecoglo Step Edge Products

Product Code	Description
F15-175 Step Nosing	75mm x 33mm aluminium (aluminum) nosing incorporating 12.6mm photoluminescent strip and 50mm black anti-slip strip. Available in lengths from 800mm to 1500mm in 100mm increments, or in full lengths of 2450mm or 3060mm.
F14-175 Step Nosing	75mm x 10mm aluminium (aluminum) nosing incorporating 12.6mm photoluminescent strip and 50mm black anti-slip strip. Available in lengths from 800mm to 1500mm in 100mm increments, or in full lengths of 2450mm or 3060mm.
E2-071 Step Edge Contrast	37mm wide aluminium (aluminum) base strip incorporating 16mm photoluminescent strip and 21mm black anti-slip strip. Available in lengths from 800mm to 1500mm in 100mm increments, or in full lengths of 2450mm or 3060mm.
E14-075 Step Edge Contrast	64mm wide aluminium (aluminum) base strip incorporating 10mm photoluminescent strip and 50mm black anti-slip strip. Available in lengths from 800mm to 1500mm in 100mm increments, or in full lengths of 2450mm or 3060mm.

B Handrail Markings

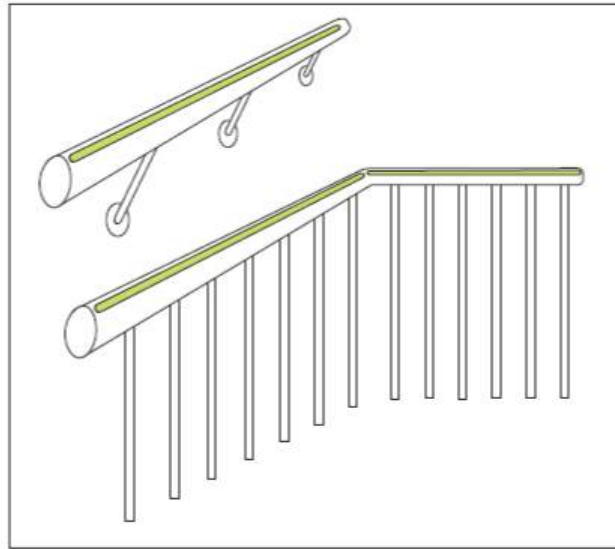

- 1 Handrail Markings Product Code: [H3-001]
Description: [15.5mm wide aluminium (aluminum) base photoluminescent handrail strip suitable for curved handrails. Available in 1000mm and 3060mm lengths.]

SPEC NOTE: The listed data included in table below provide product codes and descriptions. Specification articles (product selections) contained within square brackets [] are shown as example choices only.

[Click Here](#) to view Ecoglo Handrail Products.

Product Code	Description
H3-001 Handrail Strip	15.5mm wide aluminium (aluminum) base photoluminescent handrail strip suitable for curved handrails. Available in 1000mm and 3060mm lengths.
HREC3 End Cap	Metal End Cap for use with H3-001
G3-001 Guidance Strip	15.5mm wide aluminium (aluminum) base photoluminescent strip suitable for flat handrails. Available in 1000mm and 3060mm lengths.

C Perimeter Demarcation

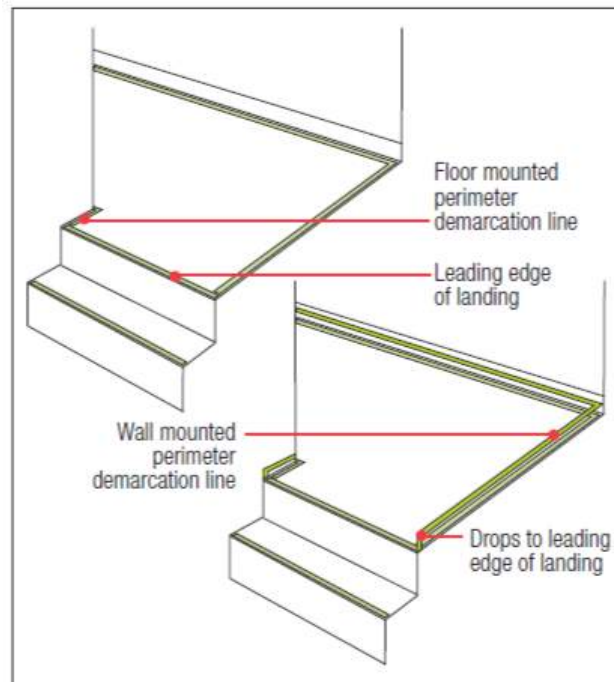

- 1 Perimeter Demarcation Product Code: [G3-001]
Description: [15.5mm wide aluminium (aluminum) base photoluminescent strip. Available in 1000mm and 3060mm lengths.]

SPEC NOTE: The listed data included in table below provide product codes and descriptions. Specification articles (product selections) contained within square brackets [] are shown as example choices only.

[Click Here](#) to view Ecoglo Perimeter Demarcation Products.

Product Code	Description
G3-001 Guidance Strip	15.5mm wide aluminium (aluminum) base photoluminescent strip. Available in 1000mm and 3060mm lengths.
T6-101 Path Marker	37mm wide aluminium (aluminum) extrusion incorporating 15.5mm wide photoluminescent strip. Available in 1000mm lengths and 3060mm lengths.
T5-101 Path Marker	51mm wide aluminium (aluminum) extrusion incorporating 15.5mm wide photoluminescent strip. Available in 1000mm lengths and 3060mm lengths.

D Obstacle Marking

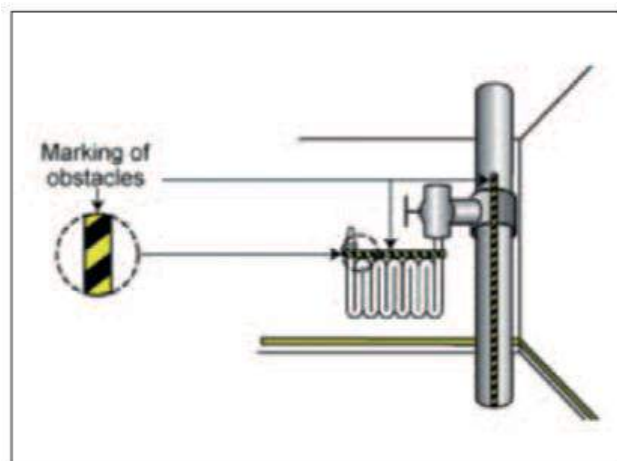

- 1 Obstacle Marking Product Code: UL-HZ2518
Description: High quality photoluminescent vinyl tape with 45 degree angled black stripes.
Available in rolls 25mm wide x 18m. (*Non-HTC Product*)

[Click Here](#) to view Ecoglo Obstruction Marking Products.

E Egress Signage

- 1 Egress Signage Product Code [S5-RML1010]
Description: [Aluminium (aluminum) base photoluminescent sign. Directional pictogram – left facing. 100mm x 100mm]

SPEC NOTE: The listed data included in table below provide product codes and descriptions. Specification articles (product selections) contained within square brackets [] are shown as example choices only. Signs can be used alone or in combination with other egress signage.

[Click Here](#) to view Ecoglo Egress Signage.

Product Code	Description
S5-RM2010	Aluminium (aluminum) base photoluminescent sign. Pictogram. 200mm x 100mm
S5-RMUA2010	Aluminium (aluminum) base photoluminescent sign. Pictogram and green arrow pointing straight up. 200mm x 100mm
S5-RMDA2010	Aluminium (aluminum) base photoluminescent sign. Pictogram and green arrow pointing straight down. 200mm x 100mm
S5-RML2010	Aluminium (aluminum) base photoluminescent sign. Pictogram and green arrow pointing left. 200mm x 100mm

S5-RMR2010	Aluminium (aluminum) base photoluminescent sign. Pictogram and green arrow pointing right. 200mm x 100mm
S5-RMUL2010	Aluminium (aluminum) base photoluminescent sign. Pictogram and green arrow pointing diagonally up left. 200mm x 100mm
S5-RMDL2010	Aluminium (aluminum) base photoluminescent sign. Pictogram and green arrow pointing diagonally down left. 200mm x 100mm
S5-RMUR2010	Aluminium (aluminum) base photoluminescent sign. Pictogram and green arrow pointing diagonally up right. 200mm x 100mm
S5-RMDR2010	Aluminium (aluminum) base photoluminescent sign. Pictogram and green arrow pointing diagonally down right. 200mm x 100mm
S5-ARS1010	Aluminium (aluminum) base photoluminescent sign. Green directional arrow – straight. 100mm x 100mm
S5-ARD1010	Aluminium (aluminum) base photoluminescent sign. Green directional arrow – diagonal. 100mm x 100mm

F Door Hardware Markings

- 1 Door Hardware Markings Product Code: S5-DHM1010
Description: Aluminium (aluminum) base photoluminescent door handle marker (100 mm x 100 mm).
- 2 Door Hardware Markings Product Code: UL-DHM3840
Description: High quality vinyl door push bar marker with “PUSH TO OPEN” text on photoluminescent background (407 mm x 38mm). Vinyl. (*Non-HTC product.*)

[Click Here](#) to view Ecoglo Door Hardware Markings.

Product Code	Description
S5-DHM1010	Aluminium (aluminum) base photoluminescent door handle marker. 100mm x 100mm
UL-DHM3840	High quality vinyl door push bar marker with “PUSH TO OPEN” text on photoluminescent background. 407mm x 38mm.

Part 3 Execution

3.1 Examination

- A Before installation, examine surfaces on which the work of this section depends. Notify [Contractor] if substrates do not comply with requirements of this section
- B Ensure any painted surfaces are fully cured.
- C Do not proceed with work of this Section until all unsatisfactory

- conditions have been corrected, if any.
 - D Commencement of Work will imply acceptance of surfaces.
- 3.2 Preparation
- A Clean surfaces to remove dirt, dust, grease, oil, loose material, frost, paint, coatings, or other matter that may affect bonding or installation of photoluminescent products.
 - B Test substrates for fit with products before using adhesives or mechanical fastening.
- 3.3 Installation
- A Install signs [as per Schedule attached at end of Section] [as indicated in Drawings] [positioned in accordance with [local building code and fire code]]
 - B Unless otherwise indicated in the specifications, install Products in accordance with manufacturer's instructions. Obtain written instructions directly from manufacturer.
- 3.4 Cleaning
- A Trim any excess adhesive with a sharp blade.
 - B At completion of installation, clean soiled Product surfaces in accordance with manufacturer's instructions.
- 3.5 Waste Management and Disposal
- A Separate waste materials for [reuse] [and] [recycling] at nearest used building materials facility.
 - B Divert unused caulking, sealants and adhesive materials from landfill through appropriate disposal procedure listed in safety data sheets (SDS).
- 3.6 Protection
- A Allow 24 hours for adhesive cure with no foot traffic permitted.
 - B Protect areas from damage using barriers, markers or temporary signs as required.
 - C Do not allow heavy objects to come into contact with installed products.

End of Section

Appendices to

Ecoglo International Ltd

Technical Manual

for

Photoluminescent Emergency Visibility



Contents	Page
Appendix 1 – Product Data Sheets	16
Appendix 2 – Installation Instructions	39
Appendix 3 – Product Test Reports	77
Appendix 4 – Safety Data Sheets	122
Appendix 5 – Quality Assurance Document	128
Appendix 6 – Warranties	130
Appendix 7 – Maintenance and Cleaning Instructions	133

Appendix 1

Ecoglo International Ltd

Product Data Sheets

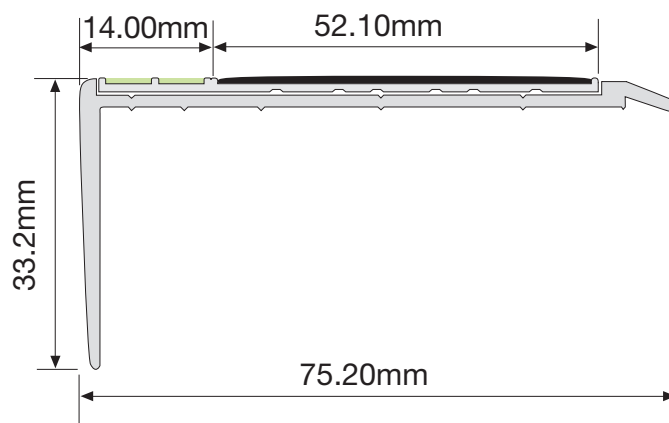
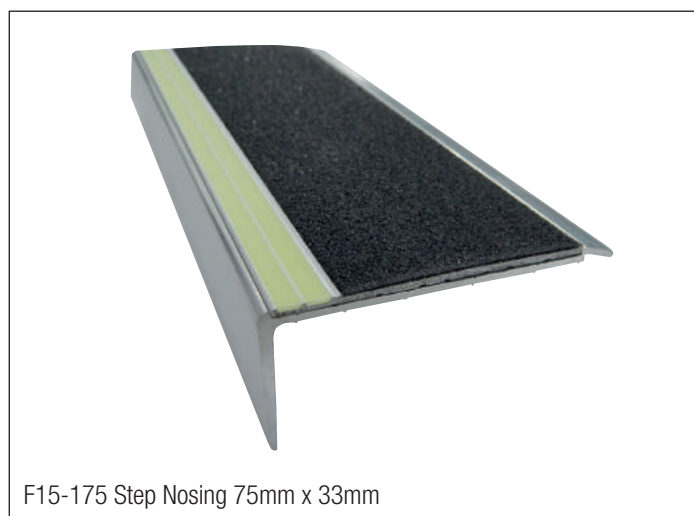

The F15-175 Step Nosing is designed to ensure visibility of steps in escape routes for compliance with International Fire Code (IFC), and any performance based building codes. The Step Nosing will be effective in all light conditions including during failure of the main lighting.

COMPLIANCE

Tested to UL 1994 specifications to meet IFC. This product has also been independently tested for use in Performance Solutions to meet the performance requirements of any performance based building codes.

The Step Nosing is suitable for use indoors and outdoors. The anti-slip material provides all weather protection from slips and falls.

Anti-slip Properties – UL410 Standard for Slip Resistance for Floor Surface Materials

AS/NZS 4586-2004 Classification: Dry: F Wet: V Ramp: R12

AS 4586-2013 Classification: P5

UV Resistance - Loss of luminance after 1000 hrs ASTM G-155 Cycle 1 exposure: <10%

Salt Spray Resistance – ASTM B117: Pass

Washability – ASTM D4828: Pass

Rate of Burning – ASTM D635: Pass

Surface Flammability - ASTM E162: Pass

Toxicity - Bombardier Toxic Gas Generation Test SMP800-C: Pass

Radioactivity - ASTM D3648: Pass

SUPPLY

The products are available in 100mm increments from 800mm to 1500mm to comply with IBC recommendations to mark the escape path on the front edge of the step to within 50mm of the wall or the side of the step. Custom lengths can also be fabricated on site from 2.45 metre and 3.06 metre lengths.

COMPOSITION

The F15-175 Step Nosing profile consists of 6060T5 aluminium extrusion, anodized (natural/silver colour) to 20 microns thickness.

Ecoglo E14-075 Step Edge Contrast is adhesively fixed into the extrusion. The high visibility E14-075 is manufactured from extruded 6063T5

aluminium section. Silicon Carbide anti-slip materials and custom made photoluminescent pigment are embedded in thermoset polyester carriers to integrally bond the active ingredients into the aluminium following curing at high temperature. The photoluminescent area is also recessed into protective channels.



INSTALLATION

The F15-175 Step Nosing can be used on a range of substrates including concrete, timber, tiles, vinyl, steel and checker plate. Uni clamp assemblies can be used for installation onto steel mesh steps.

It can also be fitted over steps with an industrial or commercial style carpet with no underlay. For thicker carpet, cut the carpet away and use a packer.

Installation is a simple process using fixers (supplied) and polyurethane adhesive.

Maximum recommended length for outdoor installation is 1500mm.

Consult Installation Instructions on website for full details and surface preparation.

PRODUCT CODE	PRODUCT DESCRIPTION	PRODUCT LENGTH
F15-175-800	Step Nosing 75mm x 33mm	800mm
F15-175-900	Step Nosing 75mm x 33mm	900mm
F15-175-1000	Step Nosing 75mm x 33mm	1000mm
F15-175-1100	Step Nosing 75mm x 33mm	1100mm
F15-175-1200	Step Nosing 75mm x 33mm	1200mm
F15-175-1300	Step Nosing 75mm x 33mm	1300mm
F15-175-1400	Step Nosing 75mm x 33mm	1400mm
F15-175-1500	Step Nosing 75mm x 33mm	1500mm

Contact

Ecoglo International Limited

Email: info@ecoglo.com **Web:** www.ecoglo.com

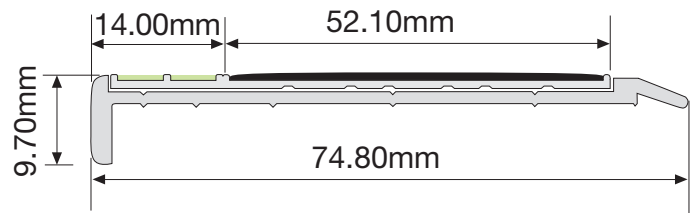
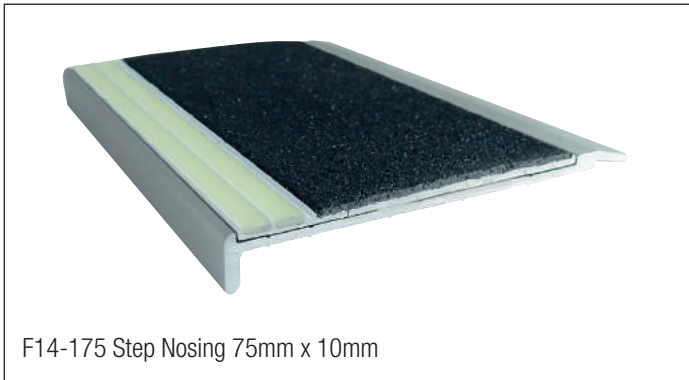

The F14-175 Step Nosing is designed to ensure visibility of steps in escape routes for compliance with International Fire Code (IFC), and any performance based building codes. The Step Nosing will be effective in all light conditions including during failure of the main lighting.

COMPLIANCE

Tested to UL 1994 specifications to meet IFC. This product has also been independently tested for use in Performance Solutions to meet the performance requirements of any performance based building codes.

The Step Nosing is suitable for use indoors and outdoors. The anti-slip material provides all weather protection from slips and falls.

Anti-slip Properties – UL410 Standard for Slip Resistance for Floor Surface Materials

AS/NZS 4586-2004 Classification: Dry: F Wet: V Ramp: R12

AS 4586-2013 Classification: P5

UV Resistance - Loss of luminance after 1000 hrs ASTM G-155 Cycle 1 exposure: <10%

Salt Spray Resistance – ASTM B117: Pass

Washability – ASTM D4828: Pass

Rate of Burning – ASTM D635: Pass

Surface Flammability - ASTM E162: Pass

Toxicity - Bombardier Toxic Gas Generation Test SMP800-C: Pass

Radioactivity - ASTM D3648: Pass

SUPPLY

The products are available in 100mm increments from 800mm to 1500mm to comply with IBC recommendations to mark the escape path on the front edge of the step to within 50mm of the wall or the side of the step. Custom lengths can also be fabricated on site from 2.45 metre and 3.06 metre lengths.

COMPOSITION

The F14-175 Step Nosing profile consists of 6060T5 aluminium extrusion, anodized (natural/silver colour) to 20 microns thickness.

Ecoglo E14-075 Step Edge Contrast is adhesively fixed into the extrusion. The high visibility E14-075 is manufactured from extruded 6063T5 aluminium section. Silicon Carbide anti-slip materials and custom made photoluminescent pigment are embedded in thermoset polyester carriers to integrally bond the active ingredients into the aluminium following cur-

ing at high temperature. The photoluminescent area is also recessed into protective channels.



INSTALLATION

The F14-175 Step Nosing can be used on a range of substrates including concrete, timber, tiles, vinyl, steel and checker plate. Uni clamp assemblies can be used for installation onto steel mesh steps.

It can also be fitted over steps with an industrial or commercial style carpet with no underlay. For thicker carpet, cut the carpet away and use a packer.

Installation is a simple process using fixers (supplied) and polyurethane adhesive.

Maximum recommended length for outdoor installation is 1500mm.

Consult Installation Instructions on website for full details and surface preparation.

PRODUCT CODE	PRODUCT DESCRIPTION	PRODUCT LENGTH
F14-175-800	Step Nosing 75mm x 10mm	800mm
F14-175-900	Step Nosing 75mm x 10mm	900mm
F14-175-1000	Step Nosing 75mm x 10mm	1000mm
F14-175-1100	Step Nosing 75mm x 10mm	1100mm
F14-175-1200	Step Nosing 75mm x 10mm	1200mm
F14-175-1300	Step Nosing 75mm x 10mm	1300mm
F14-175-1400	Step Nosing 75mm x 10mm	1400mm
F14-175-1500	Step Nosing 75mm x 10mm	1500mm

Contact

Ecoglo International Limited

Email: info@ecoglo.com Web: www.ecoglo.com

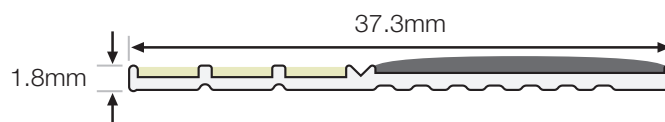

The E2-071 Step Edge Contrast is designed to ensure visibility of steps in escape routes for compliance with International Fire Code (IFC), and any performance based building codes. The Step Edge Contrast will be effective in all light conditions including during failure of the main lighting.

COMPLIANCE

Tested to UL 1994 specifications to meet IFC. This product has also been independently tested for use in Performance Solutions to meet the performance requirements of any performance based building codes.

The Step Edge Contrast is suitable for use indoors and outdoors. The anti-slip material provides all weather protection from slips and falls.

Anti-slip Properties – UL410 Standard for Slip Resistance for Floor Surface Materials

AS/NZS 4586-2004 Classification: Dry: F Wet: V Ramp: R12

AS 4586-2013 Classification: P5

UV Resistance - Loss of luminance after 1000 hrs ASTM G-155 Cycle 1 exposure: <10%

Salt Spray Resistance – ASTM B117: Pass

Washability – ASTM D4828: Pass

Rate of Burning – ASTM D635: Pass

Surface Flammability - ASTM E162: Pass

Toxicity - Bombardier Toxic Gas Generation Test SMP800-C: Pass

Radioactivity - ASTM D3648: Pass

SUPPLY

The products are available in 100mm increments from 800mm to 1500mm to comply with IBC recommendations to mark the escape path on the front edge of the step to within 50mm of the wall or the side of the step. Custom lengths can also be fabricated on site from 2.45 and 3.06 metre lengths.

COMPOSITION

Ecoglo E2-071 Step Edge Contrast is manufactured from extruded 60605T aluminium section. Silicon Carbide anti-slip materials and custom made photoluminescent pigment are embedded in thermoset polyester carriers to integrally bond the active ingredients into the aluminium following curing at high temperature. The photoluminescent area is also recessed into protective channels.



INSTALLATION

Indoors the E2-071 Step Edge Contrast can be surface mounted on all smooth surfaces. Outdoors the E2-071 Step Edge Contrast can be surface mounted onto concrete.

Installation is a simple process using polyurethane adhesive.

Maximum recommended length for outdoor installation is 1500mm.

Consult Installation Instructions on website for full details and surface preparation.

Screws can be used if adhesion is difficult.
(See order codes below for the product that best suits).

E2-071 For polyurethane adhesive fixing
E2-071P Punched for screw fixing

PRODUCT CODE	PRODUCT DESCRIPTION	PRODUCT LENGTH
E2-071-800	Step Edge Contrast 37mm	800mm
E2-071-900	Step Edge Contrast 37mm	900mm
E2-071-1000	Step Edge Contrast 37mm	1000mm
E2-071-1100	Step Edge Contrast 37mm	1100mm
E2-071-1200	Step Edge Contrast 37mm	1200mm
E2-071-1300	Step Edge Contrast 37mm	1300mm
E2-071-1400	Step Edge Contrast 37mm	1400mm
E2-071-1500	Step Edge Contrast 37mm	1500mm

Contact

Ecoglo International Limited

Email: info@ecoglo.com Web: www.ecoglo.com

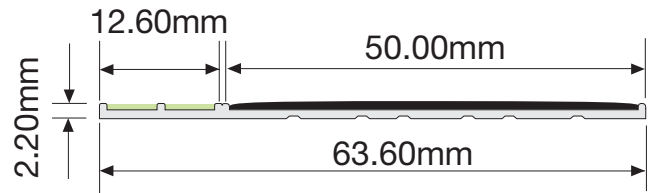
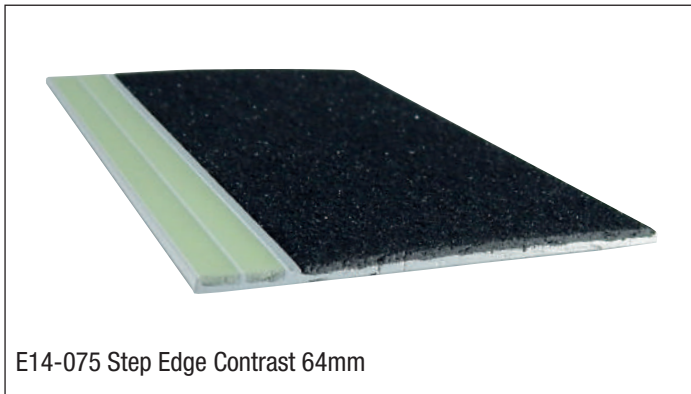

The E14-075 Step Edge Contrast is designed to ensure visibility of steps in escape routes for compliance with International Fire Code (IFC), and any performance based building codes. The Step Edge Contrast will be effective in all light conditions including during failure of the main lighting.

COMPLIANCE

Tested to UL 1994 specifications to meet IFC. This product has also been independently tested for use in Performance Solutions to meet the performance requirements of any performance based building codes.

The Step Edge Contrast is suitable for use indoors and outdoors. The anti-slip material provides all weather protection from slips and falls.

Anti-slip Properties – UL410 Standard for Slip Resistance for Floor Surface Materials

AS/NZS 4586-2004 Classification: Dry: F Wet: V Ramp: R12

AS 4586-2013 Classification: P5

UV Resistance - Loss of luminance after 1000 hrs ASTM G-155 Cycle 1 exposure: <10%

Salt Spray Resistance – ASTM B117: Pass

Washability – ASTM D4828: Pass

Rate of Burning – ASTM D635: Pass

Surface Flammability - ASTM E162: Pass

Toxicity - Bombardier Toxic Gas Generation Test SMP800-C: Pass

Radioactivity - ASTM D3648: Pass

SUPPLY

The products are available in 100mm increments from 800mm to 1500mm to comply with IBC recommendations to mark the escape path on the front edge of the step to within 50mm of the wall or the side of the step. Custom lengths can also be fabricated on site from 2.45 metre and 3.06 metre lengths.

COMPOSITION

Ecoglo E14-075 Step Edge Contrast is manufactured from extruded 60605T aluminium section. Silicon Carbide anti-slip materials and custom made photoluminescent pigment are embedded in thermoset polyester carriers to integrally bond the active ingredients into the aluminium following curing at high temperature. The photoluminescent area is also recessed into protective channels.



INSTALLATION

Indoors the E14-075 Step Edge Contrast can be surface mounted on all smooth surfaces. Outdoors the E14-075 Step Edge Contrast can be surface mounted onto concrete.

Installation is a simple process using polyurethane adhesive.

Maximum recommended length for outdoor installation is 1500mm.

Consult Installation Instructions on website for full details and surface preparation.

Screws can be used if adhesion is difficult.

(See order codes below for the product that best suits).

E14-075 For polyurethane adhesive fixing
E14-075P Punched for screw fixing

PRODUCT CODE	PRODUCT DESCRIPTION	PRODUCT LENGTH
E14-075-800	Step Edge Contrast 64mm	800mm
E14-075-900	Step Edge Contrast 64mm	900mm
E14-075-1000	Step Edge Contrast 64mm	1000mm
E14-075-1100	Step Edge Contrast 64mm	1100mm
E14-075-1200	Step Edge Contrast 64mm	1200mm
E14-075-1300	Step Edge Contrast 64mm	1300mm
E14-075-1400	Step Edge Contrast 64mm	1400mm
E14-075-1500	Step Edge Contrast 64mm	1500mm

Contact

Ecoglo International Limited

Email: info@ecoglo.com Web: www.ecoglo.com

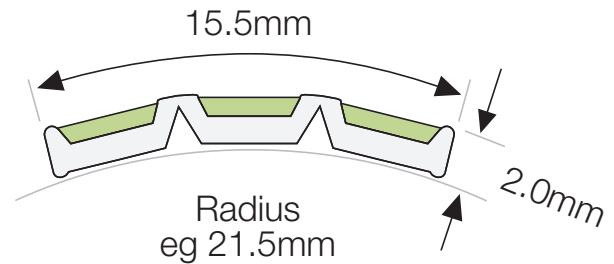

The H3-001 Handrail Marker is designed to ensure visibility of specified building features in escape routes for compliance with NFPA 101 Life Safety Code (NFPA 101) and International Fire Code (IFC), and any performance based building codes. The Handrail Marker will be effective in all light conditions including during failure of the main lighting.

COMPLIANCE

Tested to UL 1994 specifications to meet the requirements of NFPA 101 and IFC. This product has also been independently tested for use in Performance Solutions to meet the performance requirements of any performance based building codes.



The Handrail Marker is suitable for use indoors and outdoors.

- UV Resistance - Loss of luminance after 1000 hrs ASTM G-155 Cycle 1 exposure: <10%
- Salt Spray Resistance – ASTM B117: Pass
- Washability –ASTM D4828: Pass
- Rate of Burning – ASTM D635: Pass
- Surface Flammability - ASTM E162: Pass
- Toxicity - Bombardier Toxic Gas Generation Test SMP800-C: Pass
- Radioactivity - ASTM D3648: Pass

SUPPLY

The products are available in 1 metre and 3.06 metre lengths.

COMPOSITION

Ecoglo H3-001 Handrail Marker is manufactured from extruded 6060T5 aluminium section. Custom made photoluminescent pigments are embedded in thermoset polyester carriers to integrally bond the active ingredients into the aluminium following curing at high temperature. The photoluminescent area is also recessed into protective channels.



INSTALLATION

Installation is a simple process using pre-fitted release tape. Consult Installation Instructions on website for full details and surface preparation. Screws or rivets can be used if adhesion is difficult.

- H3-001T-1000** Release tape pre-fitted
- H3-001T-3060** Release tape pre-fitted

END CAPS

Metal end caps to fit H3-001 are also available if required (see insert). These are fixed using a screw or rivet and are suitable for use outdoors.

- HREC3** Metal End Cap

Contact

Ecoglo International Limited

Email: info@ecoglo.com Web: www.ecoglo.com

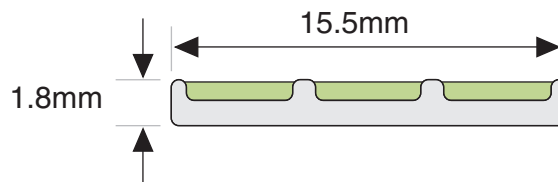

The G3-001 Guidance Strip is designed to ensure visibility of specified building features in escape routes for compliance with NFPA 101 Life Safety Code (NFPA 101) and International Fire Code (IFC), and any performance based building codes. The Guidance Strip will be effective in all light conditions including during failure of the main lighting.

COMPLIANCE

Tested to UL 1994 specifications to meet the requirements of NFPA 101 and IFC. This product has also been independently tested for use in Performance Solutions to meet the performance requirements of any performance based building codes.



The Guidance Strip is suitable for use indoors and outdoors.

UV Resistance - Loss of luminance after 1000 hrs ASTM G-155 Cycle 1 exposure: <10%

Salt Spray Resistance – ASTM B117: Pass

Washability –ASTM D4828: Pass

Rate of Burning – ASTM D635: Pass

Surface Flammability - ASTM E162: Pass

Toxicity - Bombardier Toxic Gas Generation Test SMP800-C: Pass

Radioactivity - ASTM D3648: Pass

SUPPLY

The products are available in 1 metre lengths and 3.06 metre lengths.

COMPOSITION

Ecoglo G3-001 Guidance Strip is manufactured from extruded 6060T5 aluminium section. Custom made photoluminescent pigments are embedded in thermoset polyester carriers to integrally bond the active ingredients into the aluminium following curing at high temperature. The photoluminescent area is also recessed into protective channels.



INSTALLATION

Installation is a simple process using polyurethane adhesive, fixers (screws) or pre-fitted release tape.

Fixers (screws) can be used if adhesion is difficult.

(See order codes below for the product that best suits).

Consult Installation Instructions on website for full details and surface preparation.

G3-001-1000 For polyurethane adhesive fixing

G3-001-3060 For polyurethane adhesive fixing

G3-001P-1000 Punched for screw fixing

G3-001P-3060 Punched for screw fixing

G3-001T-1000 Release tape pre-fitted

G3-001T-3060 Release tape pre-fitted

Contact

Ecoglo International Limited

Email: info@ecoglo.com Web: www.ecoglo.com

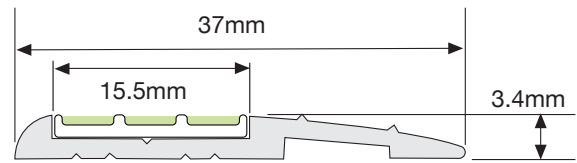
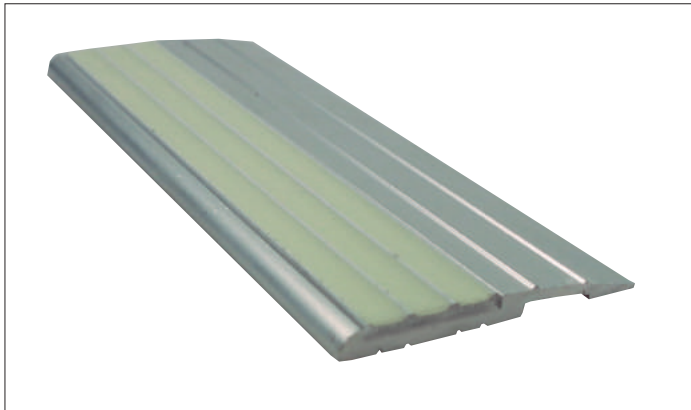

The T6-101 Path Marker is designed to ensure visibility of specified building features in escape routes for compliance with NFPA 101 Life Safety Code (NFPA 101) and International Fire Code (IFC), and any performance based building codes. The Path Marker will be effective in all light conditions including during failure of the main lighting.

COMPLIANCE

Tested to UL 1994 specifications to meet the requirements of NFPA 101 and IFC. This product has also been independently tested for use in Performance Solutions to meet the performance requirements of any performance based building codes.

The Path Marker is suitable for use indoors and outdoors.

UV Resistance - Loss of luminance after 1000 hrs ASTM G-155

Cycle 1 exposure: <10%

Salt Spray Resistance – ASTM B117: Pass

Washability – ASTM D4828: Pass

Rate of Burning – ASTM D635: Pass

Surface Flammability - ASTM E162: Pass

Toxicity - Bombardier Toxic Gas Generation Test SMP800-C: Pass

Radioactivity - ASTM D3648: Pass

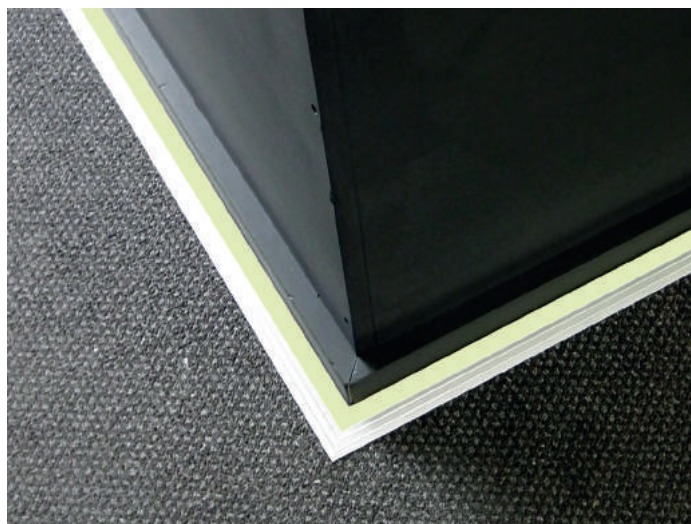

SUPPLY

The product is available in 1 metre lengths.

COMPOSITION

The Path Marker profile consists of 6060T5 aluminium extrusion, anodized (silver colour) to 12 microns thickness.

Ecoglo G3-001 is adhesively fixed into the extrusion. The high visibility G3-001 is manufactured from extruded 60605T aluminium section. Custom made photoluminescent pigments are embedded in thermoset polyester carriers to integrally bond the active ingredients into the aluminium following curing at high temperature. The photoluminescent area is also recessed into protective channels.



INSTALLATION

Designed to fit adjacent to a wall or edging, the T6-101 Path Marker can be used on a range of substrates including carpet, concrete, timber, tiles, vinyl, steel and checker plate. Uni clamp assemblies can be used for installation onto steel mesh steps. It can also be fitted over an industrial or commercial style carpet with no underlay. For thicker carpet, cut the carpet away and use a packer.

The T6-101 Path Marker can also be used to transition from one floor covering height to another.

Installation is a simple process using polyurethane adhesive or using both fixers (screws supplied) and polyurethane adhesive.

Fixers (screws) can be used if adhesion is difficult.
(See order codes below for the product that best suits).

Consult Installation Instructions on website for full details and surface preparation.

T6-101-1000 For polyurethane adhesive fixing
T6-101P-1000 Punched for screw fixing

Contact

Ecoglo International Limited

Email: info@ecoglo.com Web: www.ecoglo.com

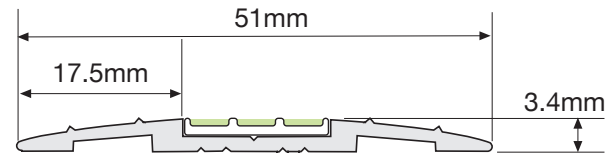
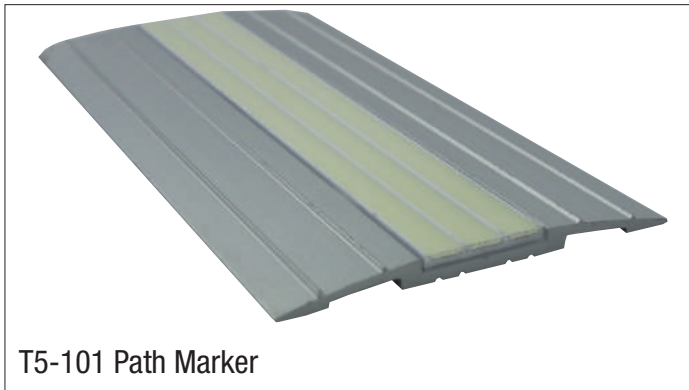

The T5-101 Path Marker is designed to ensure visibility of specified building features in escape routes for compliance with NFPA 101 Life Safety Code (NFPA 101) and International Fire Code (IFC), and any performance based building codes. The Path Marker will be effective in all light conditions including during failure of the main lighting.

COMPLIANCE

Tested to UL 1994 specifications to meet the requirements of NFPA 101 and IFC. This product has also been independently tested for use in Performance Solutions to meet the performance requirements of any performance based building codes.

The Path Marker is suitable for use indoors and outdoors.



UV Resistance - Loss of luminance after 1000 hrs ASTM G-155

Cycle 1 exposure: <10%

Salt Spray Resistance – ASTM B117: Pass

Washability –A STM D4828: Pass

Rate of Burning – ASTM D635: Pass

Surface Flammability - ASTM E162: Pass

Toxicity - Bombardier Toxic Gas Generation Test SMP800-C: Pass

Radioactivity - ASTM D3648: Pass

SUPPLY

The product is available in 1 metre lengths.

COMPOSITION

The Path Marker profile consists of 6060T5 aluminium extrusion, anodized (silver colour) to 12 microns thickness.

Ecoglo G3-001 is adhesively fixed into the extrusion. The high visibility G3-001 is manufactured from extruded 60605T aluminium section.

Custom made photoluminescent pigments are embedded in thermoset polyester carriers to integrally bond the active ingredients into the aluminium following curing at high temperature. The photoluminescent area is also recessed into protective channels.



INSTALLATION

The T5-101 Path Marker can be used on a range of substrates including carpet, concrete, timber, tiles, vinyl, steel and checker plate. Uni clamp assemblies can be used for installation onto steel mesh steps. It can also be fitted over an industrial or commercial style carpet with no underlay. For thicker carpet, cut the carpet away and use a packer.

Installation is a simple process using polyurethane adhesive or using both fixers (screws supplied) and polyurethane adhesive.

Fixers (screws) can be used if adhesion is difficult.
(See order codes below for the product that best suits).

Consult Installation Instructions on website for full details and surface preparation.

T5-101-1000 For polyurethane adhesive fixing
T5-101P-1000 Punched for screw fixing

Contact

Ecoglo International Limited

Email: info@ecoglo.com Web: www.ecoglo.com

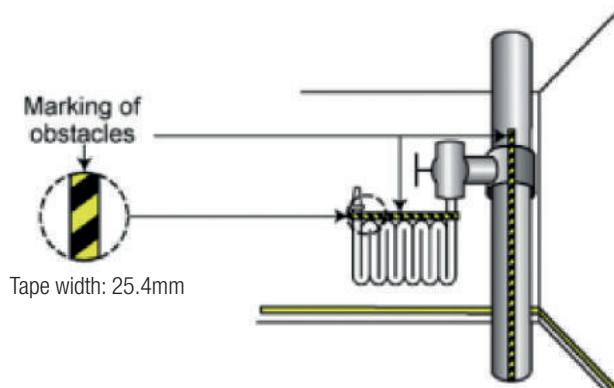

The UL-HZ2518 Hazard Tape is designed to ensure visibility of obstacles in escape routes for compliance with NFPA 101 Life Safety Code (NFPA 101) and International Fire Code (IFC). The Hazard Tape will be effective in all light conditions including failure of the main lighting.

COMPLIANCE

UL Listed and NFPA 101 and IFC compliant. Can be used in Performance Solutions to meet the requirements of any performance based building codes.

Brightness - High visibility in light or dark conditions meets UL 1994.

SUPPLY

The photoluminescent hazard tape is available in rolls of 18 metres.

COMPOSITION

Manufactured using high quality vinyl, the UL-HZ2518 Hazard Tape has a premium integrated adhesive which provides a superior bond to a variety of surfaces.

INSTALLATION

Installation is a simple process using pre-fitted release tape.

UL-HZ2518 25.4mm wide x 18m roll

Contact

Ecoglo International Limited

Email: info@ecoglo.com Web: www.ecoglo.com



Ecoglo S5 “Pictogram” signs are designed to be clearly visible to persons approaching the exit for compliance with NFPA 101 Life Safety Code and International Fire Code (IFC). The signs will be clearly visible and readily understandable under all conditions of foreseeable use, including emergency conditions.

SIGN DEFINITION

Exit straight on from here.

COMPLIANCE

Ecoglo S5 “Pictogram” signs have been tested to UL 1994 specifications to meet NFPA 101 and IFC.

PERFORMANCE

A charging source of 1 ft-candle (11 lux) of fluorescent illumination is necessary for 60 minutes to ensure that minimum luminance requirements of 30 mcd/m² at 10 minutes and 5 mcd/m² at 90 minutes are met after failure of the main lighting.

UV Resistance – Loss of luminance after 1000 hrs ASTM G-155
Cycle 1 exposure: <10%

Salt Spray Resistance – ASTM B117: Pass

Washability – ASTM D4828: Pass

Rate of Burning – ASTM D635: Pass

Surface Flammability – ASTM E162: Pass

Toxicity – Bombardier Toxic Gas Generation Test SMP800-C: Pass

Radioactivity – ASTM D3648: Pass

High Temperature Curing: Pass

SUPPLY

The product is available in the following size.

PRODUCT CODE	PRODUCT NAME	SIGN DEFINITION	SIGN SIZE
S5-RM2010	Pictogram	Exit straight on from here	200mm x 100mm

COMPOSITION

The high visibility flat panel is manufactured from 5005 0.9mm aluminium sheet. Custom made photoluminescent pigments are embedded in thermoset polyester carriers to integrally bond the active ingredients onto the aluminium sheet following curing at high temperature.



INSTALLATION

The sign is supplied with pre-fitted release tape for fixing flat on a wall or door.

Contact

Ecoglo International Limited

Email: info@ecoglo.com Web: www.ecoglo.com

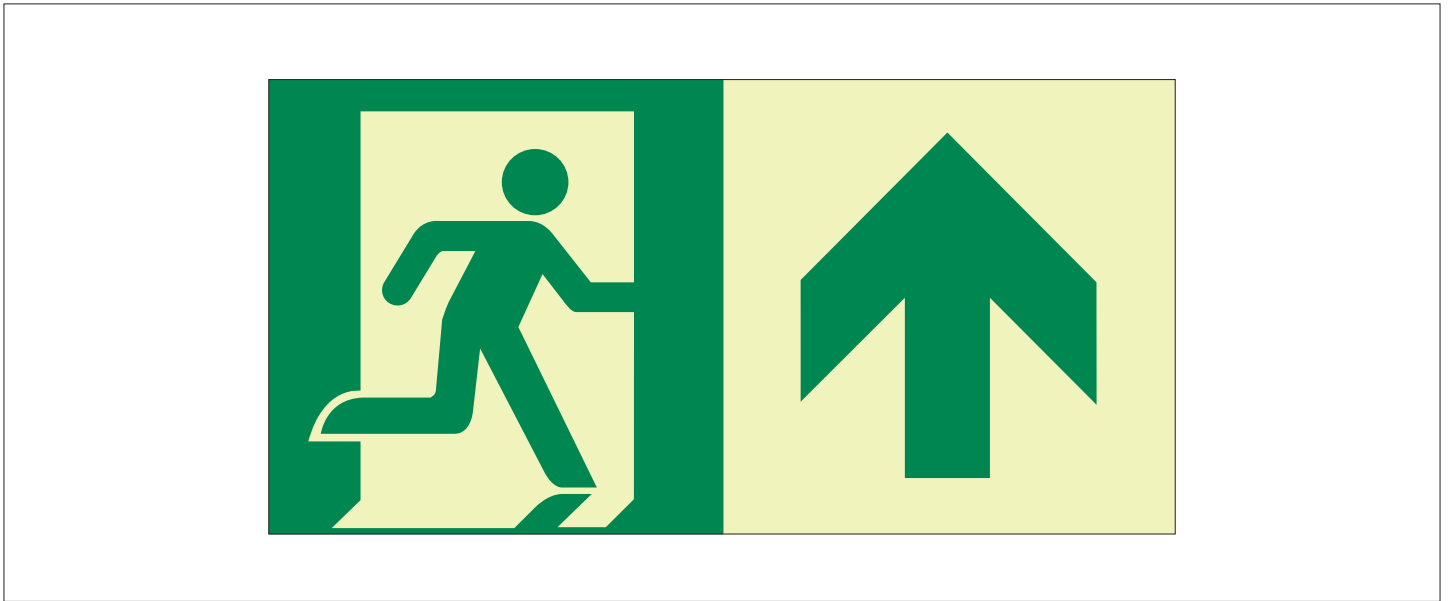

Ecoglo S5 “Pictogram Up Arrow” signs are designed to be clearly visible to persons approaching the exit for compliance with NFPA 101 Life Safety Code and International Fire Code (IFC). The signs will be clearly visible and readily understandable under all conditions of foreseeable use, including emergency conditions.

SIGN DEFINITION

Exit straight on from here.

COMPLIANCE

Ecoglo S5 “Pictogram Up Arrow” signs have been tested to UL 1994 specifications to meet NFPA 101 and IFC.

PERFORMANCE

A charging source of 1 ft-candle (11 lux) of fluorescent illumination is necessary for 60 minutes to ensure that minimum luminance requirements of 30 mcd/m² at 10 minutes and 5 mcd/m² at 90 minutes are met after failure of the main lighting.

UV Resistance – Loss of luminance after 1000 hrs ASTM G-155 Cycle 1 exposure: <10%

Salt Spray Resistance – ASTM B117: Pass

Washability – ASTM D4828: Pass

Rate of Burning – ASTM D635: Pass

Surface Flammability – ASTM E162: Pass

Toxicity – Bombardier Toxic Gas Generation Test SMP800-C: Pass

Radioactivity – ASTM D3648: Pass

High Temperature Curing: Pass

SUPPLY

The product is available in the following size.

PRODUCT CODE	PRODUCT NAME	SIGN DEFINITION	SIGN SIZE
S5-RMUA2010	Pictogram Up Arrow	Exit straight on from here	200mm x 100mm

COMPOSITION

The high visibility flat panel is manufactured from 5005 0.9mm aluminium sheet. Custom made photoluminescent pigments are embedded in thermoset polyester carriers to integrally bond the active ingredients onto the aluminium sheet following curing at high temperature.



INSTALLATION

The sign is supplied with pre-fitted release tape for fixing flat on a wall or door.

Contact

Ecoglo International Limited

Email: info@ecoglo.com Web: www.ecoglo.com

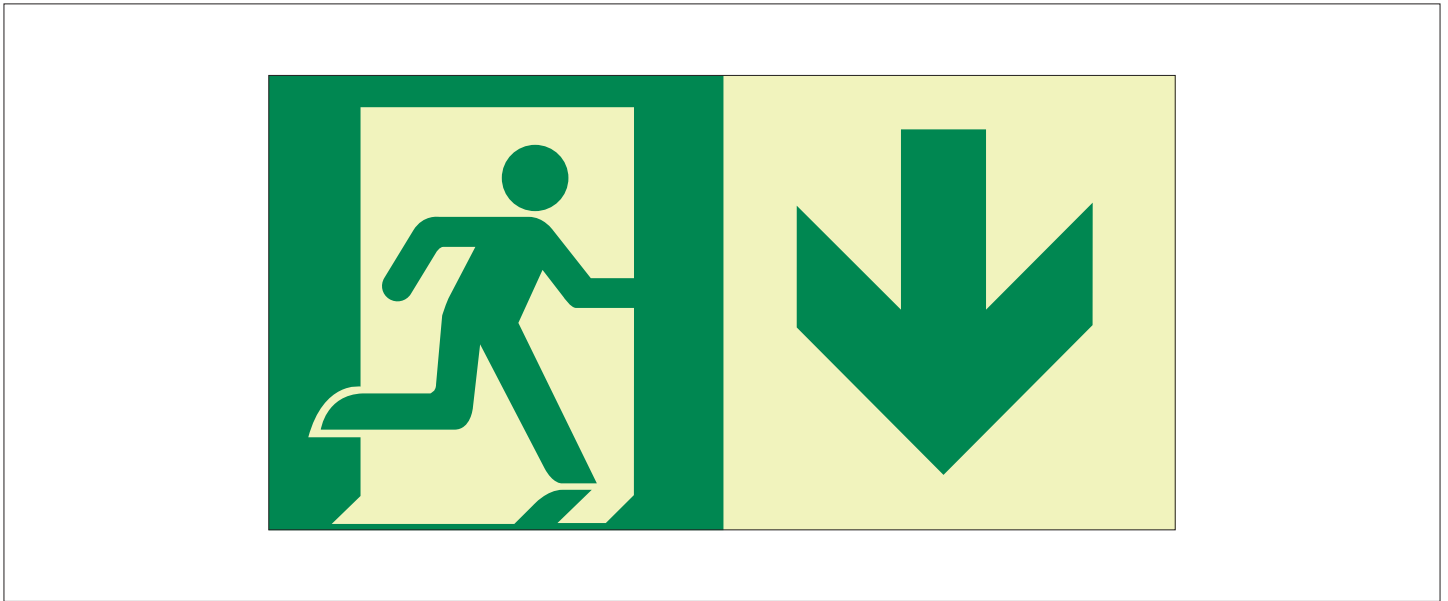

Ecoglo S5 “Pictogram Down Arrow” signs are designed to be clearly visible to persons approaching the exit for compliance with NFPA 101 Life Safety Code and International Fire Code (IFC). The signs will be clearly visible and readily understandable under all conditions of foreseeable use, including emergency conditions.

SIGN DEFINITION

Exit down from here.

COMPLIANCE

Ecoglo S5 “Pictogram Down Arrow” signs have been tested to UL 1994 specifications to meet NFPA 101 and IFC.

PERFORMANCE

A charging source of 1 ft-candle (11 lux) of fluorescent illumination is necessary for 60 minutes to ensure that minimum luminance requirements of 30 mcd/m² at 10 minutes and 5 mcd/m² at 90 minutes are met after failure of the main lighting.

UV Resistance – Loss of luminance after 1000 hrs ASTM G-155 Cycle 1 exposure: <10%

Salt Spray Resistance – ASTM B117: Pass

Washability – ASTM D4828: Pass

Rate of Burning – ASTM D635: Pass

Surface Flammability – ASTM E162: Pass

Toxicity – Bombardier Toxic Gas Generation Test SMP800-C: Pass

Radioactivity – ASTM D3648: Pass

High Temperature Curing: Pass

SUPPLY

The product is available in the following size.

PRODUCT CODE	PRODUCT NAME	SIGN DEFINITION	SIGN SIZE
S5-RMDA2010	Pictogram Down Arrow	Exit down from here	200mm x 100mm

COMPOSITION

The high visibility flat panel is manufactured from 5005 0.9mm aluminium sheet. Custom made photoluminescent pigments are embedded in thermoset polyester carriers to integrally bond the active ingredients onto the aluminium sheet following curing at high temperature.



INSTALLATION

The sign is supplied with pre-fitted release tape for fixing flat on a wall or door.

Contact

Ecoglo International Limited

Email: info@ecoglo.com **Web:** www.ecoglo.com



Ecoglo S5 “Pictogram Left Arrow” signs are designed to be clearly visible to persons approaching the exit for compliance with NFPA 101 Life Safety Code and International Fire Code (IFC). The signs will be clearly visible and readily understandable under all conditions of foreseeable use, including emergency conditions.

SIGN DEFINITION

Exit left from here.

COMPLIANCE

Ecoglo S5 “Pictogram Left Arrow” signs have been tested to UL 1994 specifications to meet NFPA 101 and IFC.

PERFORMANCE

A charging source of 1 ft-candle (11 lux) of fluorescent illumination is necessary for 60 minutes to ensure that minimum luminance requirements of 30 mcd/m² at 10 minutes and 5 mcd/m² at 90 minutes are met after failure of the main lighting.

UV Resistance – Loss of luminance after 1000 hrs ASTM G-155 Cycle 1 exposure: <10%

Salt Spray Resistance – ASTM B117: Pass

Washability – ASTM D4828: Pass

Rate of Burning – ASTM D635: Pass

Surface Flammability – ASTM E162: Pass

Toxicity – Bombardier Toxic Gas Generation Test SMP800-C: Pass

Radioactivity – ASTM D3648: Pass

High Temperature Curing: Pass

SUPPLY

The product is available in the following size.

PRODUCT CODE	PRODUCT NAME	SIGN DEFINITION	SIGN SIZE
S5-RML2010	Pictogram Left Arrow	Exit left from here	200mm x 100mm

COMPOSITION

The high visibility flat panel is manufactured from 5005 0.9mm aluminium sheet. Custom made photoluminescent pigments are embedded in thermoset polyester carriers to integrally bond the active ingredients onto the aluminium sheet following curing at high temperature.



INSTALLATION

The sign is supplied with pre-fitted release tape for fixing flat on a wall or door.

Contact

Ecoglo International Limited

Email: info@ecoglo.com Web: www.ecoglo.com

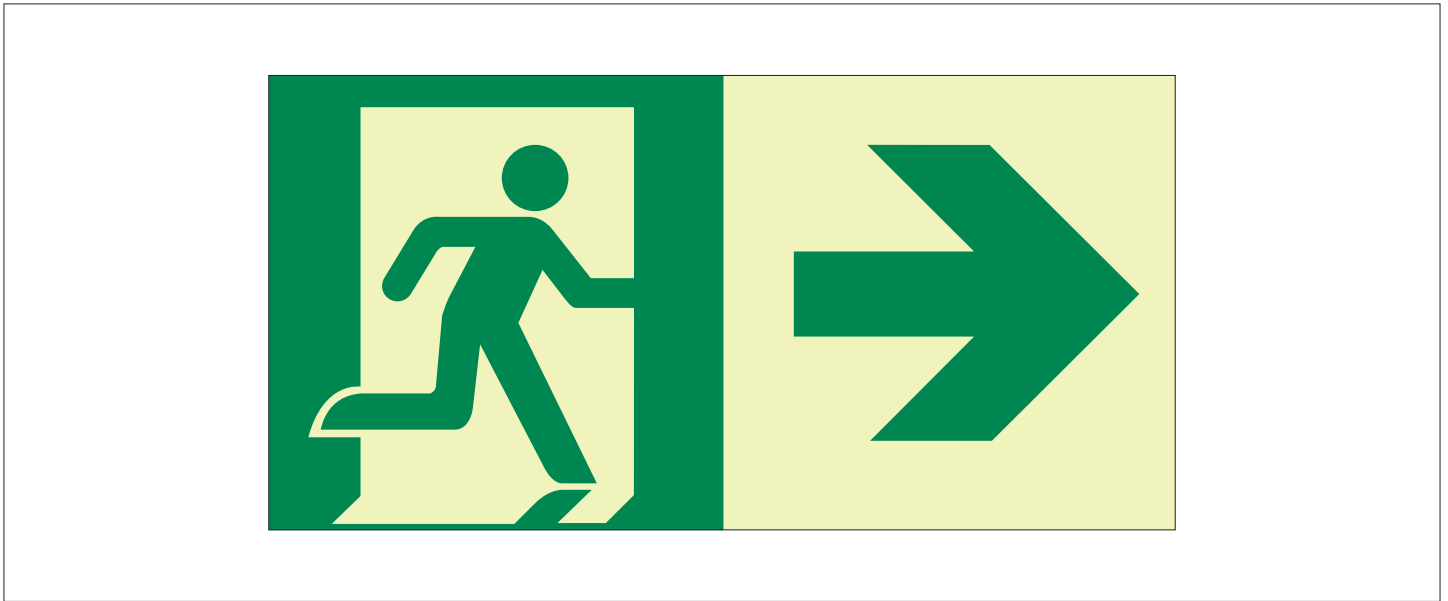

Ecoglo S5 “Pictogram Right Arrow” signs are designed to be clearly visible to persons approaching the exit for compliance with NFPA 101 Life Safety Code and International Fire Code (IFC). The signs will be clearly visible and readily understandable under all conditions of foreseeable use, including emergency conditions.

SIGN DEFINITION
Exit right from here.

COMPLIANCE
Ecoglo S5 “Pictogram Right Arrow” signs have been tested to UL 1994 specifications to meet NFPA 101 and IFC.

PERFORMANCE
A charging source of 1 ft-candle (11 lux) of fluorescent illumination is necessary for 60 minutes to ensure that minimum luminance requirements of 30 mcd/m² at 10 minutes and 5 mcd/m² at 90 minutes are met after failure of the main lighting.

UV Resistance – Loss of luminance after 1000 hrs ASTM G-155 Cycle 1 exposure: <10%

Salt Spray Resistance – ASTM B117: Pass

Washability – ASTM D4828: Pass

Rate of Burning – ASTM D635: Pass

Surface Flammability – ASTM E162: Pass

Toxicity – Bombardier Toxic Gas Generation Test SMP800-C: Pass

Radioactivity – ASTM D3648: Pass

High Temperature Curing: Pass

SUPPLY

The product is available in the following size.

PRODUCT CODE	PRODUCT NAME	SIGN DEFINITION	SIGN SIZE
S5-RMR2010	Pictogram Right Arrow	Exit right from here	200mm x 100mm

COMPOSITION

The high visibility flat panel is manufactured from 5005 0.9mm aluminium sheet. Custom made photoluminescent pigments are embedded in thermoset polyester carriers to integrally bond the active ingredients onto the aluminium sheet following curing at high temperature.



INSTALLATION

The sign is supplied with pre-fitted release tape for fixing flat on a wall or door.

Contact

Ecoglo International Limited

Email: info@ecoglo.com Web: www.ecoglo.com



Ecoglo S5 “Pictogram Up Left Arrow” signs are designed to be clearly visible to persons approaching the exit for compliance with NFPA 101 Life Safety Code and International Fire Code (IFC). The signs will be clearly visible and readily understandable under all conditions of foreseeable use, including emergency conditions.

SIGN DEFINITION

Exit up left from here.

COMPLIANCE

Ecoglo S5 “Pictogram Up Left Arrow” signs have been tested to UL 1994 specifications to meet NFPA 101 and IFC.

PERFORMANCE

A charging source of 1 ft-candle (11 lux) of fluorescent illumination is necessary for 60 minutes to ensure that minimum luminance requirements of 30 mcd/m² at 10 minutes and 5 mcd/m² at 90 minutes are met after failure of the main lighting.

UV Resistance – Loss of luminance after 1000 hrs ASTM G-155 Cycle 1 exposure: <10%

Salt Spray Resistance – ASTM B117: Pass

Washability – ASTM D4828: Pass

Rate of Burning – ASTM D635: Pass

Surface Flammability – ASTM E162: Pass

Toxicity – Bombardier Toxic Gas Generation Test SMP800-C: Pass

Radioactivity – ASTM D3648: Pass

High Temperature Curing: Pass

SUPPLY

The product is available in the following size.

PRODUCT CODE	PRODUCT NAME	SIGN DEFINITION	SIGN SIZE
S5-RMUL2010	Pictogram Up Left Arrow	Exit up left from here	200mm x 100mm

COMPOSITION

The high visibility flat panel is manufactured from 5005 0.9mm aluminium sheet. Custom made photoluminescent pigments are embedded in thermoset polyester carriers to integrally bond the active ingredients onto the aluminium sheet following curing at high temperature.



INSTALLATION

The sign is supplied with pre-fitted release tape for fixing flat on a wall or door.

Contact

Ecoglo International Limited

Email: info@ecoglo.com Web: www.ecoglo.com



Ecoglo S5 “Pictogram Down Left Arrow” signs are designed to be clearly visible to persons approaching the exit for compliance with NFPA 101 Life Safety Code and International Fire Code (IFC). The signs will be clearly visible and readily understandable under all conditions of foreseeable use, including emergency conditions.

SIGN DEFINITION

Exit down left from here.

COMPLIANCE

Ecoglo S5 “Pictogram Down Left Arrow” signs have been tested to UL 1994 specifications to meet NFPA 101 and IFC.

PERFORMANCE

A charging source of 1 ft-candle (11 lux) of fluorescent illumination is necessary for 60 minutes to ensure that minimum luminance requirements of 30 mcd/m² at 10 minutes and 5 mcd/m² at 90 minutes are met after failure of the main lighting.

UV Resistance – Loss of luminance after 1000 hrs ASTM G-155 Cycle 1 exposure: <10%

Salt Spray Resistance – ASTM B117: Pass

Washability – ASTM D4828: Pass

Rate of Burning – ASTM D635: Pass

Surface Flammability – ASTM E162: Pass

Toxicity – Bombardier Toxic Gas Generation Test SMP800-C: Pass

Radioactivity – ASTM D3648: Pass

High Temperature Curing: Pass

SUPPLY

The product is available in the following size.

PRODUCT CODE	PRODUCT NAME	SIGN DEFINITION	SIGN SIZE
S5-RMDL2010	Pictogram Down Left Arrow	Exit down left from here	200mm x 100mm

COMPOSITION

The high visibility flat panel is manufactured from 5005 0.9mm aluminium sheet. Custom made photoluminescent pigments are embedded in thermoset polyester carriers to integrally bond the active ingredients onto the aluminium sheet following curing at high temperature.



INSTALLATION

The sign is supplied with pre-fitted release tape for fixing flat on a wall or door.

Contact

Ecoglo International Limited

Email: info@ecoglo.com **Web:** www.ecoglo.com

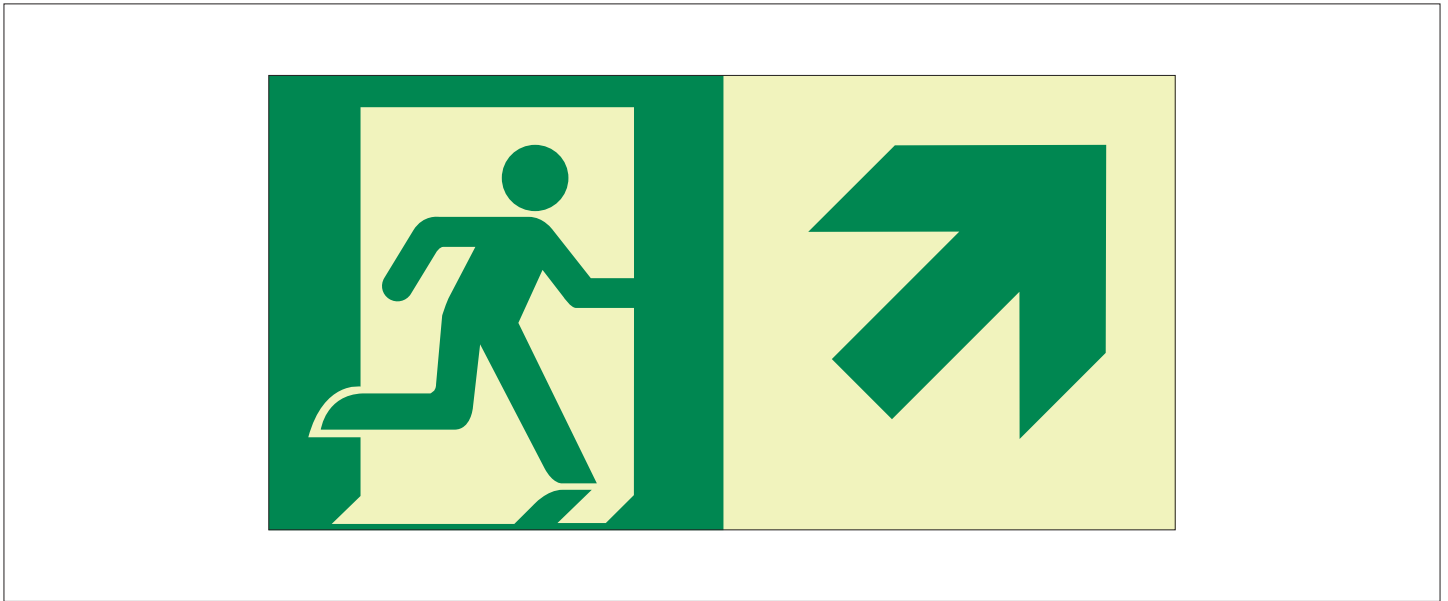

Ecoglo S5 “Pictogram Up Right Arrow” signs are designed to be clearly visible to persons approaching the exit for compliance with NFPA 101 Life Safety Code and International Fire Code (IFC). The signs will be clearly visible and readily understandable under all conditions of foreseeable use, including emergency conditions.

SIGN DEFINITION

Exit up right from here.

COMPLIANCE

Ecoglo S5 “Pictogram Up Right Arrow” signs have been tested to UL 1994 specifications to meet NFPA 101 and IFC.

PERFORMANCE

A charging source of 1 ft-candle (11 lux) of fluorescent illumination is necessary for 60 minutes to ensure that minimum luminance requirements of 30 mcd/m² at 10 minutes and 5 mcd/m² at 90 minutes are met after failure of the main lighting.

UV Resistance – Loss of luminance after 1000 hrs ASTM G-155 Cycle 1 exposure: <10%

Salt Spray Resistance – ASTM B117: Pass

Washability – ASTM D4828: Pass

Rate of Burning – ASTM D635: Pass

Surface Flammability – ASTM E162: Pass

Toxicity – Bombardier Toxic Gas Generation Test SMP800-C: Pass

Radioactivity – ASTM D3648: Pass

Radioactivity – ASTM D3648: Pass

High Temperature Curing: Pass

SUPPLY

The product is available in the following size.

PRODUCT CODE	PRODUCT NAME	SIGN DEFINITION	SIGN SIZE
S5-RMUR2010	Pictogram Up Right Arrow	Exit up right from here	200mm x 100mm

COMPOSITION

The high visibility flat panel is manufactured from 5005 0.9mm aluminium sheet. Custom made photoluminescent pigments are embedded in thermoset polyester carriers to integrally bond the active ingredients onto the aluminium sheet following curing at high temperature.



INSTALLATION

The sign is supplied with pre-fitted release tape for fixing flat on a wall or door.

Contact

Ecoglo International Limited

Email: info@ecoglo.com **Web:** www.ecoglo.com

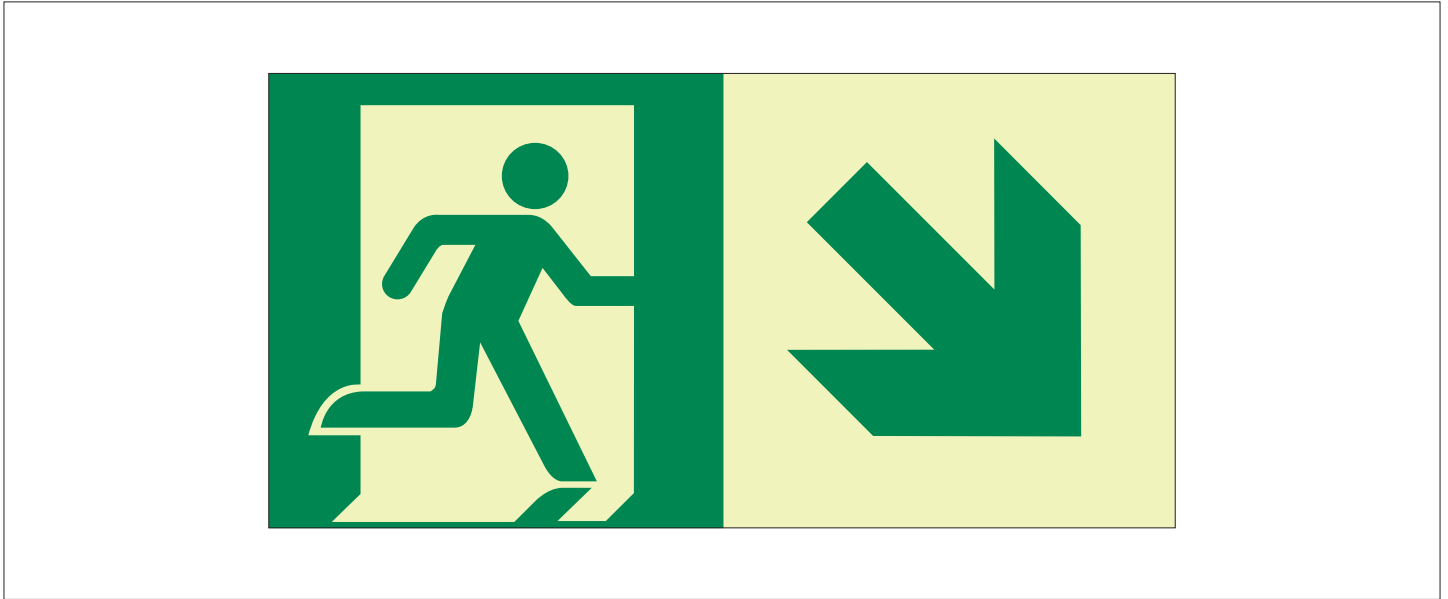

Ecoglo S5 “Pictogram Down Right Arrow” signs are designed to be clearly visible to persons approaching the exit for compliance with NFPA 101 Life Safety Code and International Fire Code (IFC). The signs will be clearly visible and readily understandable under all conditions of foreseeable use, including emergency conditions.

SIGN DEFINITION

Exit down right from here.

COMPLIANCE

Ecoglo S5 “Pictogram Down Right Arrow” signs have been tested to UL 1994 specifications to meet NFPA 101 and IFC.

PERFORMANCE

A charging source of 1 ft-candle (11 lux) of fluorescent illumination is necessary for 60 minutes to ensure that minimum luminance requirements of 30 mcd/m² at 10 minutes and 5 mcd/m² at 90 minutes are met after failure of the main lighting.

UV Resistance – Loss of luminance after 1000 hrs ASTM G-155 Cycle 1 exposure: <10%

Salt Spray Resistance – ASTM B117: Pass

Washability – ASTM D4828: Pass

Rate of Burning – ASTM D635: Pass

Surface Flammability – ASTM E162: Pass

Toxicity – Bombardier Toxic Gas Generation Test SMP800-C: Pass

Radioactivity – ASTM D3648: Pass

High Temperature Curing: Pass

SUPPLY

The product is available in the following size.

PRODUCT CODE	PRODUCT NAME	SIGN DEFINITION	SIGN SIZE
S5-RMDR2010	Pictogram Down Right Arrow	Exit down right from here	200mm x 100mm

COMPOSITION

The high visibility flat panel is manufactured from 5005 0.9mm aluminium sheet. Custom made photoluminescent pigments are embedded in thermoset polyester carriers to integrally bond the active ingredients onto the aluminium sheet following curing at high temperature.



INSTALLATION

The sign is supplied with pre-fitted release tape for fixing flat on a wall or door.

Contact

Ecoglo International Limited

Email: info@ecoglo.com Web: www.ecoglo.com

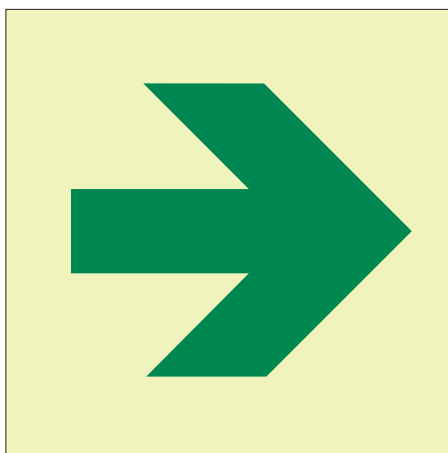

Ecoglo S5 “Directional Arrow Straight” signs are designed to be clearly visible to persons approaching the exit for compliance with NFPA 101 Life Safety Code and International Fire Code (IFC). The signs will be clearly visible and readily understandable under all conditions of foreseeable use, including emergency conditions.

SIGN DEFINITION

Travel in this direction.

COMPLIANCE

Ecoglo S5 “Directional Arrow Straight” signs are tested to UL 1994 specifications to meet NFPA 101 and IFC.

PERFORMANCE

A charging source of 1 ft-candle (11 lux) of fluorescent illumination is necessary for 60 minutes to ensure that minimum luminance requirements of 30 mcd/m² at 10 minutes and 5 mcd/m² at 90 minutes are met after failure of the main lighting.

UV Resistance – Loss of luminance after 1000 hrs ASTM G-155 Cycle 1 exposure: <10%

Salt Spray Resistance – ASTM B117: Pass

Washability – ASTM D4828: Pass

Rate of Burning – ASTM D635: Pass

Surface Flammability – ASTM E162: Pass

Toxicity – Bombardier Toxic Gas Generation Test SMP800-C: Pass

Radioactivity – ASTM D3648: Pass

High Temperature Curing: Pass

SUPPLY

The product is available in the following size. (The sign can be used alone or in combination with Ecoglo directional pictogram signs.)

PRODUCT CODE	PRODUCT NAME	SIGN DEFINITION	SIGN SIZE
S5-ARS1010	Directional Arrow Straight	Travel in this direction	100mm x 100mm

COMPOSITION

The high visibility flat panel is manufactured from 5005 0.9mm aluminium sheet. Custom made photoluminescent pigments are embedded in thermoset polyester carriers to integrally bond the active ingredients onto the aluminium sheet following curing at high temperature.



INSTALLATION

The sign is supplied with pre-fitted release tape for fixing flat on a wall or door.

Contact

Ecoglo International Limited

Email: info@ecoglo.com **Web:** www.ecoglo.com

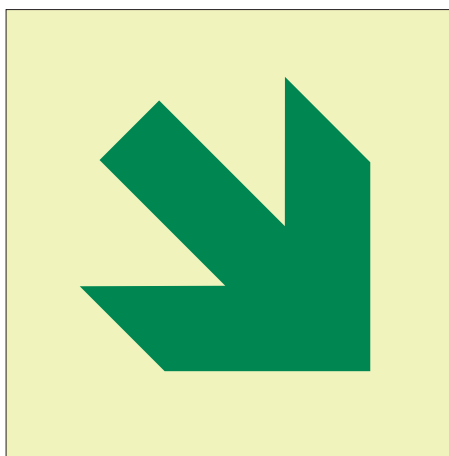

Ecoglo S5 “Directional Arrow Diagonal” signs are designed to be clearly visible to persons approaching the exit for compliance with NFPA 101 Life Safety Code and International Fire Code (IFC). The signs will be clearly visible and readily understandable under all conditions of foreseeable use, including emergency conditions.

SIGN DEFINITION

Travel in this direction.

COMPLIANCE

Ecoglo S5 “Directional Arrow Diagonal” signs are tested to UL 1994 specifications to meet NFPA 101 and IFC.

PERFORMANCE

A charging source of 1 ft-candle (11 lux) of fluorescent illumination is necessary for 60 minutes to ensure that minimum luminance requirements of 30 mcd/m² at 10 minutes and 5 mcd/m² at 90 minutes are met after failure of the main lighting.

UV Resistance – Loss of luminance after 1000 hrs ASTM G-155 Cycle 1 exposure: <10%

Salt Spray Resistance – ASTM B117: Pass

Washability – ASTM D4828: Pass

Rate of Burning – ASTM D635: Pass

Surface Flammability – ASTM E162: Pass

Toxicity – Bombardier Toxic Gas Generation Test SMP800-C: Pass

Radioactivity – ASTM D3648: Pass

High Temperature Curing: Pass

SUPPLY

The product is available in the following size. (The sign can be used alone or in combination with Ecoglo directional pictogram signs.)

PRODUCT CODE	PRODUCT NAME	SIGN DEFINITION	SIGN SIZE
S5-ARD1010	Directional Arrow Diagonal	Travel in this direction	100mm x 100mm

COMPOSITION

The high visibility flat panel is manufactured from 5005 0.9mm aluminium sheet. Custom made photoluminescent pigments are embedded in thermoset polyester carriers to integrally bond the active ingredients onto the aluminium sheet following curing at high temperature.



INSTALLATION

The sign is supplied with pre-fitted release tape for fixing flat on a wall or door.

Contact

Ecoglo International Limited

Email: info@ecoglo.com **Web:** www.ecoglo.com



Ecoglo S5 Door Handle Markers are designed to be clearly visible to persons approaching the exit for compliance with NFPA 101 Life Safety Code and International Fire Code (IFC). The Door Handle Marker will be visible and readily understandable under all conditions of foreseeable use, including emergency conditions.

COMPLIANCE

Ecoglo S5 Door Handle Markers meet ASTM E 2072 requirements and are NFPA 101 Life Safety Code and IFC compliant.

PERFORMANCE

A charging source of 1 ft-candle (11 lux) of fluorescent illumination is necessary for 60 minutes to ensure that minimum luminance requirements of 30 mcd/m² at 10 minutes and 5 mcd/m² at 90 minutes are met after failure of the main lighting.

UV Resistance – Loss of luminance after 1000 hrs ASTM G-155

Cycle 1 exposure: <10%

Salt Spray Resistance – ASTM B117: Pass

Washability – ASTM D4828: Pass

Rate of Burning – ASTM D635: Pass

Surface Flammability – ASTM E162: Pass

Toxicity – Bombardier Toxic Gas Generation Test SMP800-C: Pass

Radioactivity – ASTM D3648: Pass

SUPPLY

The product is available in the following size.

PRODUCT CODE	PRODUCT NAME	MARKER DEFINITION	MARKER SIZE
S5-DHM1010	Door Handle Marker	Not applicable	100mm x 100mm

COMPOSITION

The high visibility flat panel is manufactured from 5005 0.9mm aluminium sheet. Custom made photoluminescent pigments are embedded in thermoset polyester carriers to integrally bond the active ingredients onto the aluminium sheet following curing at high temperature.



INSTALLATION

The door marker is supplied with pre-fitted release tape for fixing flat on a door.

Contact

Ecoglo International Limited

Email: info@ecoglo.com Web: www.ecoglo.com

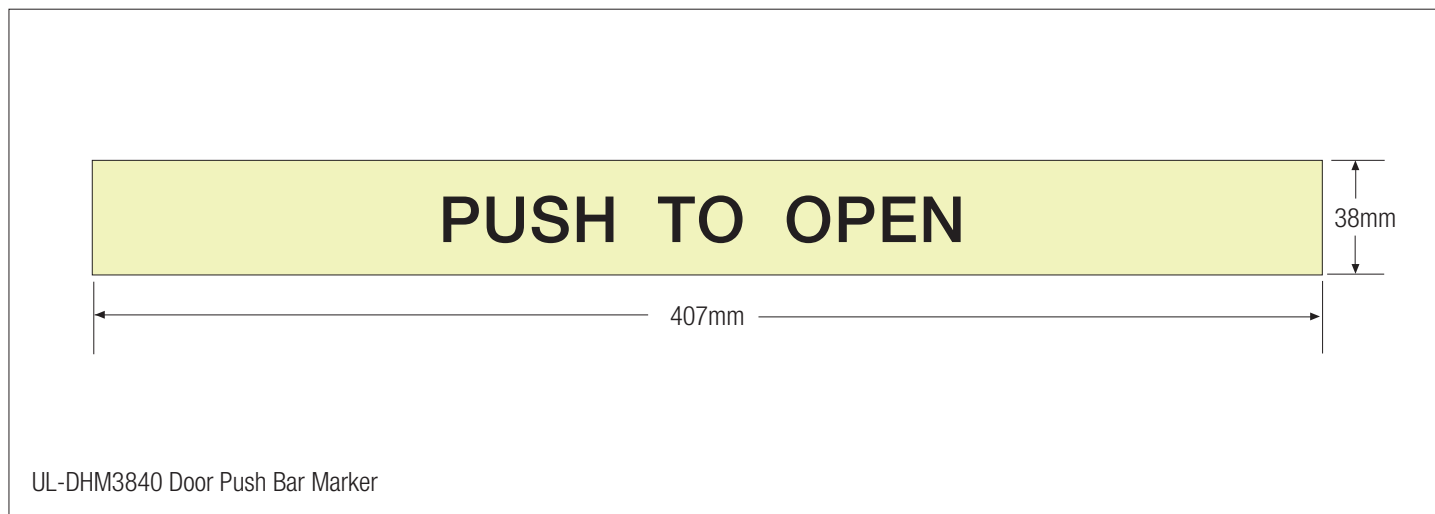

The UL-DHM3840 Door Push Bar Marker is designed to ensure visibility of panic bars on doors in escape routes for compliance with NFPA 101 Life Safety Code and International Fire Code (IFC). The Door Push Bar Marker will be effective in all light conditions including failure of the main lighting.

COMPLIANCE

UL Listed and NFPA 101 and IFC compliant. Can be used in Performance Solutions to meet the requirements of any performance based building codes.

Brightness - High visibility in light or dark conditions meets UL 1994.

SUPPLY

The product is available in the following size.

PRODUCT CODE	PRODUCT DESCRIPTION	PRODUCT LENGTH
UL-DHM3840	Door Push Bar Marker 38mm	407mm

COMPOSITION

The UL-DHM3840 Door Push Bar Marker is manufactured from high quality vinyl.

INSTALLATION

The Door Push Bar Marker is supplied with pre-fitted release tape making installation a simple process.

Contact

Ecoglo International Limited

Email: info@ecoglo.com Web: www.ecoglo.com

Appendix 2

Ecoglo International Ltd

Installation Instructions

Installation Instructions For

Major Projects with On Site Cutting

E-Series Step Edge Contrast

Ecoglo markers are to be installed only where there will be sufficient natural or artificial light to keep them charged whenever the building is occupied.

If unsure, contact Ecoglo

Major Projects with On Site Cutting E-Series Step Edge Contrast

Materials Required

- Work benches up to 2.0m long
- Tape measure/ruler/pencil
- Guillotine - Hand Operated Plate Shears (Model: Opti PS150 or similar)
- Hole spacing jig (using end stops and/or alignment marks)
- Bench hand punch
- Battery drill
- Drill bit for countersink
- Angle grinder (for surface preparation)
- Abrasive flap disc (for surface preparation)
- Methylated spirits and cloth
- Würth KD Bond and Seal or Bostik Seal'n'Flex FC adhesive (expected usage 25 - 30 metres per 600 ml sausage) or similar quality polyurethane adhesive
- Caulking (adhesive) gun
- Nozzles for caulking gun
- Fixers - 6G x 25mm
- Anchors (plugs) - 5 x 25mm
- Brush and pan

Major Projects with On Site Cutting E-Series Step Edge Contrast

Cutting

1. Measuring the Contrast Strip

- Measure the required length of the strip.
- Mark the position where you will cut.

2. Cutting the Contrast Strip to Length

- Contrast strips contain silicon carbide grit that rapidly blunt high-speed saw blades, so a manual guillotine - also referred to as hand shears (example pictured below) - is needed to cut the strip.
- Lay the strip, upside down, into the guillotine.
- Use the guillotine to cut the strip - it is recommended that the strips are always cut while upside down to eliminate potential bruising of the strip.
- Cut the strip at the length measured.

NOTE: The maximum recommended length for installation in outdoor situations is 1.5 metres, with a minimum 3mm gap between lengths. This allows for thermal expansion in extreme weather conditions and also aids in water drainage off the step tread.



Guillotine - Model: Opti PS150

Punch Fixer Holes (if using fixers)

- Refer to the hole drilling/punching specification table below to determine positioning and number of holes.
- Ensure outside holes are approximately 50 mm in from each end.
- Mark where holes are to be made - this should be through the anti-slip material.
- Using a bench hand punch (example below) create holes for fixers.
- If countersinking is required, use a hand drill and countersink drill bit to make fixer flush with strip.



Using guillotine (hand shears) to cut strip



Bench Hand Punch - Model Bramley 023 (HP-10), 3-10mm

Hole Drilling Specifications

Strip Length	Less than 350mm	350mm - 650mm	650mm - 950mm	950mm - 1250mm	1250mm - 1500mm
Number of Holes	2	3	4	5	6

Major Projects with On Site Cutting E-Series Step Edge Contrast

Installation

1. Preparation of Surface

- Thoroughly clean the surface with industrial strength cleaner if necessary.
- Allow surface to dry.
- If painted, sealed or coated, remove using an angle grinder with abrasive flap disc (see image below).
- Brush/vacuum off the dust.
- Wipe surface with acetone.



Note: Installation onto Concrete Surfaces

- It is preferable to use adhesive only for concrete installations. The adhesive will allow some movement to compensate for thermal contraction and expansion and will provide durable adhesion to the concrete substrate.

** Where adhesive only installation is preferred on surfaces that have a sealer applied (eg concrete, exposed aggregate and some tiles) a test patch should be laid and allowed to temperature cycle over a minimum of 14 days to ensure a good bond is achieved.*

If the adhesive does not hold then mechanical fixers should be used.

If mechanical fixing is not practical due to potential damage to the substrate please contact Ecoglo.

2. Alignment of the Strips

- Mark 50mm from the left edge of the top step.
- Mark 50mm from the left edge of the bottom step.
- Place a string line between the marks to ensure the strip on each step will be correctly aligned.

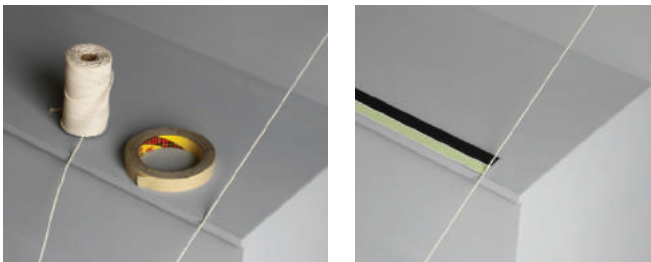

- The maximum recommended length for installation in outdoor situations is 1.5 metres.
- There must be a 3mm gap between lengths. This allows for thermal expansion in extreme weather conditions and also aids in water drainage off the step tread.
- Leave a 3mm gap either side of built-in steps

3. Preparation of the Strip

- Clean back of contrast strip with soft cloth and if necessary use methylated spirits (or similar solvent) to remove oil or grease
- Allow to dry for approximately 1 minute.

(For installations requiring adhesive & fixers go to step 8)

4. Applying the Adhesive

- Apply a 3mm zigzag bead of polyurethane adhesive (such as Wurth KD Bond and Seal or Bostik Seal n Flex FC) to the back of the strip, 3mm in from the edges.
- Take care to keep adhesive away from any drill holes.
- Continue along the length of the strip.



Adhesive Usage:

E2 Series - 30 metres per 600ml

E4 Series - 25 metres per 600ml

E14 Series - 25 metres per 600ml

Ecoglo can supply Wurth KD Bond and Seal in 600ml Sausage form with Applicator Gun.

5. Placement of the Strip

- Line up the strip with your alignment marks and position approximately 2-3mm back from the front straight edge of the step.
- Place in position with the photoluminescent (light green) component of the strip to the leading edge of the step (see image below).

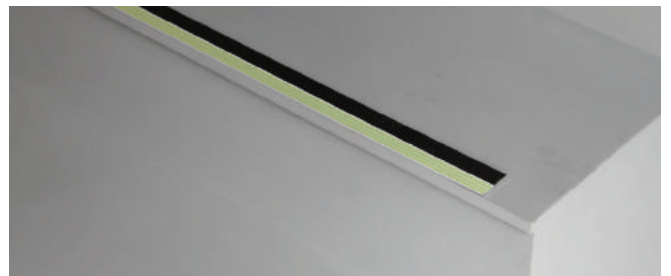

Steps with exposed sides:

Ensure the nosing is set back from exposed side by at least 20mm to ensure the outer edge of the nosing does not present a sharp hazard.

Tile Steps:

If the tiles are not perfectly aligned then the contrast strip must be cut into pieces the width of each tile and placed so that the grout line is exposed.

Major Projects with On Site Cutting E-Series Step Edge Contrast

6. Apply Pressure to the Strip

- Apply even pressure to spread the adhesive beneath the strip using a hand roller.
- If necessary stand on each strip to ensure good contact between the strip and the step.



7. Allow the Adhesive to Cure

- Immediately following installation close off the area for a period of 8 hours to avoid the Ecoglo strip being moved whilst the adhesive is in the early stages of “cure”.
- Wait until adhesive has fully cured (allow at least 24 hours) before trimming any excess from each strip with a sharp blade.

8. Installations requiring Adhesive and Fixers

a. Outdoor Timber installations - 2 stage process

Note: Indoor installations only require adhesive

For outdoor timber installations both adhesive and fixers should be used because installation onto outdoor timber surfaces varies due to the uneven nature of timber, the various types of timber (eg pine or kwila), the protective coating (eg paint or sealer) and seasonal temperature variances.

Stage 1:

- Apply adhesive as per steps 3-4 taking care to keep adhesive away from pre drilled holes.
- Place strip as per steps 5-6.
- Leave the adhesive to cure for 7 days before installing the fixers.

Stage 2:

- Place a screw fixer into each hole and drill in securely using a battery drill.
- Do not fully tighten the fixers to avoid compressing the adhesive.

For timber installations the strips should be pre-drilled through the anti-slip material. The table below shows the number of drill holes required to allow for the natural contraction and expansion of timber.



b. Concrete Installations

Note: Adhesive only is usually sufficient, however, if adhesive and fixers are preferred, follow the instructions below.

DO NOT use fixers without considering the effects of temperature variance and thermal expansion, especially outdoors. If in doubt contact Ecoglo.

- Position the strip approximately 2-3mm from the front straight edge of the step and using the pre-drilled holes mark where the fixers are to be placed.
- Using a 6mm masonry bit and a concrete drill, drill the hole that will house the plastic anchor.
- Wipe away any dust or debris.
- Place the anchor fully into the holes.
- Apply adhesive as per steps 3-4 taking care to keep adhesive away from the pre-drilled holes.
- Place strip as per steps 5-6.
- Place a screw fixer into each hole and drill in securely using a battery drill.
- Do not fully tighten the fixers to avoid compressing the adhesive.

Installation Instructions For

Major Projects with On Site Cutting

F-Series Step Nosings

**(Includes cutting and installing of
G6-001 Step Edge Returns)**

Ecoglo markers are to be installed only where there will be sufficient natural or artificial light to keep them charged whenever the building is occupied.

If unsure, contact Ecoglo



Major Projects with On Site Cutting

F-Series Step Nosings

Materials Required

- Work benches up to 2.0m long
- Input/output benching or racks
- Tape measure/ruler/pencil
- Drop saw with high speed tungsten carbide tip blade (eg Sash Pro 250mm diameter, 80 tooth) mounted on bench with support arms/guides for extrusions, and adjustable end stops
- Guillotine - Hand Operated Plate Shears (Model: Opti PS150, seen over page, or similar)
- Brush and pan
- Methylated spirits and cloth
- String
- Battery drill
- 5mm drill bit
- Drill suitable for concrete substrate
- 6mm masonry drill bits
- Anchors (plugs) - 6mm x 30mm
- Würth KD Bond and Seal or Bostik Seal'n'Flex FC adhesive (expected usage 11 metres per 600 ml sausage) or similar quality polyurethane adhesive
- Caulking (adhesive) gun
- Nozzles for caulking gun
- Fixers - 8G x 32mm (and 6G x 25mm for G6-011)
- Hand press-roller
- Alcohol wipes

Major Projects with On Site Cutting F-Series Step Nosings

Cutting

1. Measuring the Nosing and Insert

- Measure the required length of the nosing and the insert.
- Mark the position on both pieces where you will cut.



2. Cutting the Nosing to Length

- Use the drop saw with a suitable tungsten carbide tip blade.
- Cut the nosing at the length measured.

NOTE: The maximum recommended length for installation in outdoor situations is 1.5 metres, with a minimum 3mm gap between lengths. This allows for thermal expansion in extreme weather conditions and also aids in water drainage off the step tread.



3. Cutting the Insert to Length

- Step edge contrast inserts contain silicon carbide grit that rapidly blunt high-speed saw blades, so a manual guillotine (as pictured below) is needed to cut the insert.
- Lay the insert strip, upside down, into the pre-cut nosing. Mark the insert strip for cutting.
- Remove the insert strip from the nosing and place into the guillotine. Use the guillotine to cut the insert - it is recommended that the inserts are always cut while upside down to eliminate potential bruising of the contrast strip.

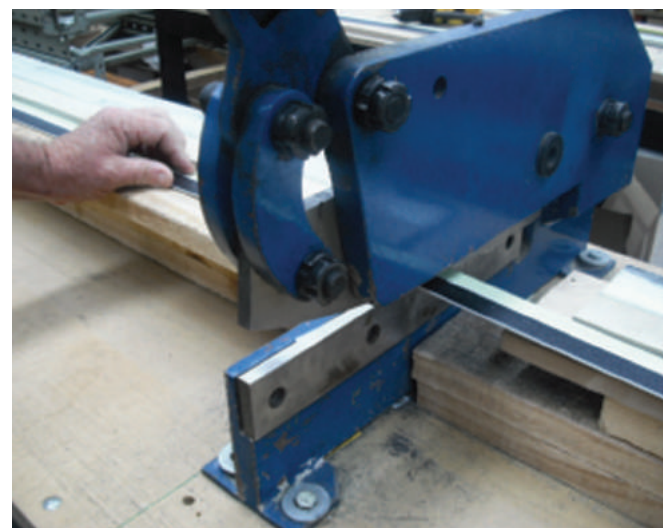

Major Projects with On Site Cutting F-Series Step Nosings

Installation

1. Preparation of Surface

- Brush the surface clean of dust and debris. If necessary, clean with an industrial cleaner.
- Remove any paint or sealant and then allow the surface to dry.
- It is better for adhesion if timber surfaces are dry.



Steps with exposed sides:

Ensure the nosing is set back from exposed side by at least 20mm to ensure the outer edge of the nosing does not present a sharp hazard.

Built-in steps, Installed outdoors:

Leave a 3mm gap between the nosing and the built-in sides, to allow for thermal expansion, and water drainage.

NOTE: The maximum recommended length for installation in outdoor situations is 1.5 metres. A 3mm expansion / drainage gap must be left between lengths.

2. Alignment (for installation onto more than one step)

- Place one piece of step nosing on the top step and one on the bottom step.
- Run a string line from the left edge of the top nosing to the left edge of the bottom nosing.
- This will give you a straight, true line.

NOTE: If Step Edge Returns are to be fitted ensure enough space is left either side of the nosing



3. Locating Holes for Fixers (for Timber skip to step 5)

- Place the nosing firmly against the riser of the step.
- Line it up with your string line.
- Mark the location of the drill holes with the drill.
- Remove the nosing.

NOTE: F15, F14 and F9 nosings come pre-drilled with holes every 100mm. You only require 4 fixers per metre. Where appropriate, fixers should be zigzagged across the pre-drilled holes to give maximum support to both sides of the nosing.

4. Drilling holes for fixers (for Timber skip to step 5)

- Using a 6mm masonry bit, and a concrete drill, drill the hole that will house the plastic anchor.
- Wipe away any dust or debris.
- Place the plastic anchor fully in to the holes.



5. Applying Adhesive

- Lay a 3mm bead of polyurethane adhesive (such as Wurth KD Bond and Seal or Bostik Seal n Flex FC) in a wave pattern over the full length of the underside of the nosing.
- Keep the adhesive clear of the outside edge and the drill holes.



Major Projects with On Site Cutting F-Series Step Nosings

6. Securing the nosing profile

- Place the nosing firmly back onto the step, lining up the drill holes.
- Tighten the screws firmly using a battery hand drill- this will create a strong, even bond.
- For fixing on to wooden substrate follow the previous instructions but the plugs are not required.

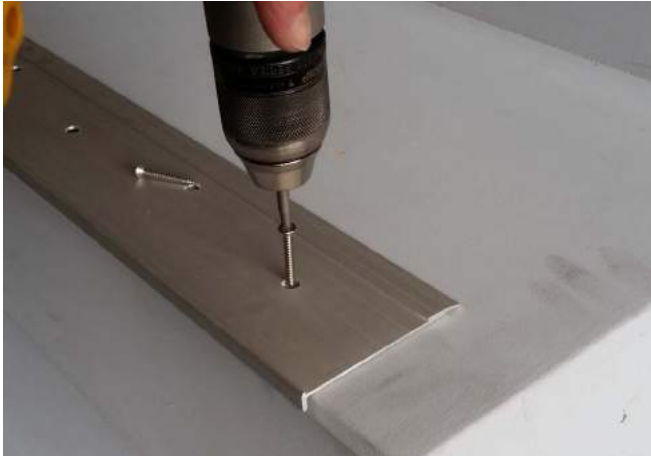

Adhesive Usage:

11 metres per 600ml sausage

Ecoglo supply screw fixers with all orders and can also supply Wurth KD Bond and Seal in 600ml Sausage form with Applicator Gun.

7. Fixing Insert Strip

- Check nosing extrusion channel is free from dust, dirt, grease and moisture.
- Dust or wipe with methylated spirits or damp cloth if required.
- Lay a zigzag of adhesive, 1mm deep, 3mm wide on to the strip.
- Ensure that you don't over apply adhesive as it will spill out once the insert is placed into the nosing.



8. Insert strip into the nosing

- Line up the strip insert then place firmly onto the nosing.
- Press in place to ensure even contact between the adhesive and the surface of the channel.
- Use a roller or your foot to apply firm downward pressure.
- Use an alcohol wipe to remove any spill over of adhesive.

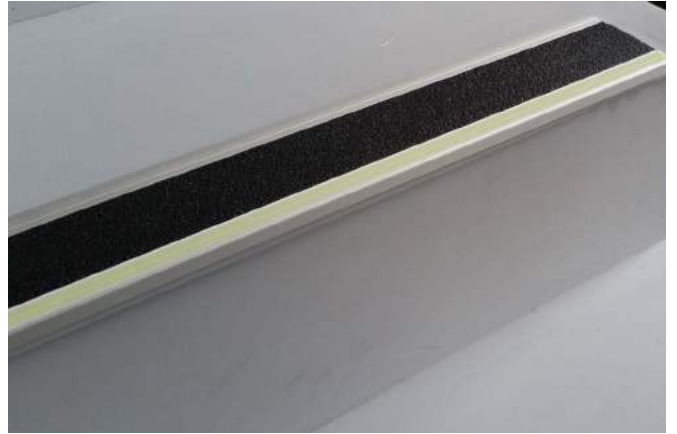

9. Curing of Adhesive

- Allow approximately 24 hours for adhesive to cure.

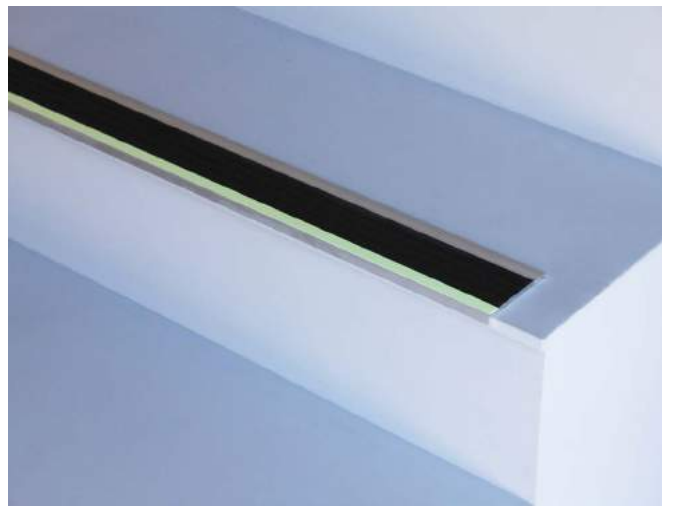

Major Projects with On Site Cutting

G6-001 Step Edge Returns

1. Measuring the Return

- Measure the required length of the returns.
- Mark the position on the strip where you will cut.

2. Cutting the Return to Length

- The Step Edge Return contains aluminium oxide that can blunt high-speed saw blades, so a manual guillotine is needed to cut the strip.
- It is recommended that the returns are always cut while upside down to eliminate potential bruising of the strip and to preserve blade life.

3. Drilling Holes for Fixers

A minimum of 2 fixers are required for each return

- Using a hand drill with a 5mm drill bit, drill a hole 10-25mm in from each end of each strip.
- In most cases 2 holes will be sufficient, however lengths longer than 350mm will also require a fixer in the middle of the strip.

Installation

Installation is a two-step process using adhesive and fixers.

1. Locating Holes for Fixers

- Place each piece at a right angle to the step nosing as in the diagram below.
- The outside edge of the return should be between 5-10mm from the outside edge of the step.
- Allow an expansion gap of at least 5mm with the riser of the step above.
- Mark the location of the drill holes.
- Remove the strip.
- Using a 6mm masonry bit and a concrete drill, drill the hole that will house the plastic anchor.
- Wipe away any dust or debris.
- Place the anchor fully into the holes.

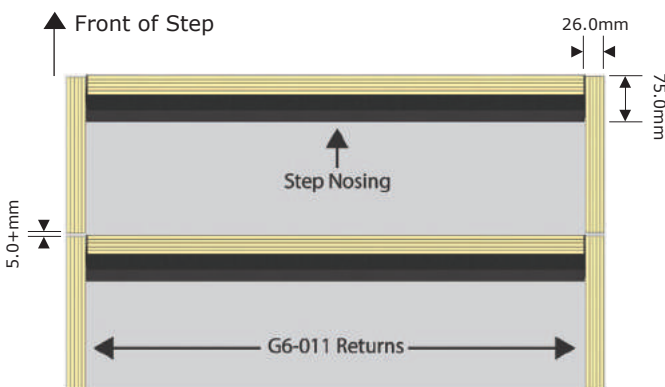

The Step Edge Returns should be placed as above

2. Preparation of Return

- Clean back of strip with a soft cloth and if necessary use methylated spirits (or similar solvent) to remove oil or grease
- Allow to dry for approximately 1 minute.

3. Applying the Adhesive

- Apply a 3mm zigzag bead of polyurethane adhesive (such as Wurth KD Bond and Seal or Bostik Seal n Flex FC) to the back of the strip.
- Continue along the length of the strip.
- Keep the adhesive clear of the outside edge and the drill holes.

4. Placement of the Returns

- Place each piece as in the diagram at 1. ensuring the holes in the strip line up with the drill holes.

5. Apply Pressure to the Return

- Apply even pressure to spread the adhesive beneath the strip using a hand roller.
- If necessary stand on each strip to ensure good contact between the strip and the step.

5. Allow the Adhesive to Cure

- Immediately following installation close off the area for a period of 8 hours to avoid the Ecoglo strip being moved whilst the adhesive is in the early stages of "cure".
- Wait until adhesive has fully cured (allow at least 24 hours) before trimming any excess from each strip with a sharp blade.

6. Securing the Return

- Place a screw fixer into each hole and drill in securely using a battery drill.
- Do not fully tighten the fixers to avoid compressing the adhesive.

Installation Instructions For

Step Edge Contrast E Series

Concrete and Timber

These instructions also apply to G6-003 Guidance Strips when used on steps

Ecoglo markers are to be installed only where there will be sufficient natural or artificial light to keep them charged whenever the building is occupied.

If unsure, contact Ecoglo

Step Edge Contrast - E Series Concrete and Timber

And G6-003 Guidance Strips when used on steps

1. Preparation of Surface

- Thoroughly clean the surface with industrial strength cleaner if necessary.
- Allow surface to dry.
- **If painted or coated, remove using an angle grinder with abrasive flap disc.**
- Brush/vacuum off the dust.
- Wipe surface with acetone.



Note: Installation onto Concrete Surfaces

- It is preferable to use adhesive only for concrete installations. The adhesive will allow some movement to compensate for thermal contraction and expansion and will provide durable adhesion to the concrete substrate.

** Where adhesive only installation is preferred on surfaces that have a sealer applied (eg concrete, exposed aggregate and some tiles) a test patch should be laid and allowed to temperature cycle over a minimum of 14 days to ensure a good bond is achieved.*

If the adhesive does not hold then mechanical fixers should be used.

If mechanical fixing is not practical due to potential damage to the substrate please contact Ecoglo.

2. Alignment of the Strips

- Mark 50mm from the left edge of the top step.
- Mark 50mm from the left edge of the bottom step.
- Place a string line between the marks to ensure the strip on each step will be correctly aligned.

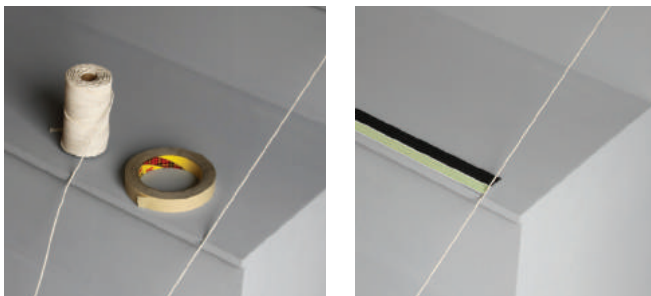

- The maximum recommended length for installation in outdoor situations is 1.5 metres.
- There must be a 3mm gap between lengths. This allows for thermal expansion in extreme weather conditions and also aids in water drainage off the step tread.
- Leave a 3mm gap either side of built-in steps

3. Preparation of the Strip

- Clean back of contrast strip with soft cloth and if necessary use methylated spirits (or similar solvent) to remove oil or grease
- Allow to dry for approximately 1 minute.

(For installations requiring adhesive & fixers go to step 8)

4. Applying the Adhesive

- Apply a 3mm zigzag bead of polyurethane adhesive (such as Wurth KD Bond and Seal or Bostik Seal n Flex FC) to the back of the strip, 3mm in from the edges.
- Continue along the length of the strip.



Adhesive Usage:

E2 Series - 30 metres per 600ml

E4 Series - 25 metres per 600ml

E14 Series - 25 metres per 600ml

G6-003 - 30 metres per 600ml

Ecoglo can supply Wurth KD Bond and Seal in 600ml Sausage form with Applicator Gun.

5. Placement of the Strip

- Line up the strip with your alignment marks and position approximately 2-3mm back from the front straight edge of the step.
- Place in position with the photoluminescent (light green) component of the strip to the leading edge of the step (see image below).

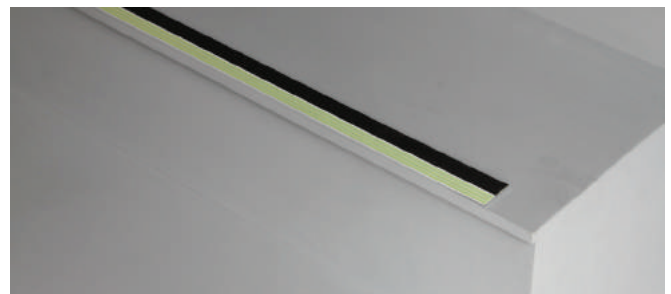

Steps with exposed sides:

Ensure the nosing is set back from exposed side by at least 20mm to ensure the outer edge of the nosing does not present a sharp hazard.

Tile Steps

If the tiles are not perfectly aligned then the contrast strip must be cut into pieces the width of each tile and placed so that the grout line is exposed.

Step Edge Contrast - E Series Concrete and Timber

And G6-003 Guidance Strips when used on steps

6. Apply Pressure to the Strip

- Apply even pressure to spread the adhesive beneath the strip using a hand roller.
- If necessary stand on each strip to ensure good contact between the strip and the step.



7. Allow the Adhesive to Cure

- Immediately following installation close off the area for a period of 8 hours to avoid the Ecoglo strip being moved whilst the adhesive is in the early stages of "cure".
- Wait until adhesive has fully cured (allow at least 24 hours) before trimming any excess from each strip with a sharp blade.

8. Installations requiring Adhesive and Fixers

a. Outdoor Timber installations - 2 stage process

Note: Indoor installations only require adhesive

For outdoor timber installations both adhesive and fixers should be used because installation onto outdoor timber surfaces varies due to the uneven nature of timber, the various types of timber (eg pine or kwila), the protective coating (eg paint or sealer) and seasonal temperature variances.

Stage 1:

- Apply adhesive as per steps 3-4 taking care to keep adhesive away from pre drilled holes.
- Place strip as per steps 5-6.
- Leave the adhesive to cure for 7 days before installing the fixers.

Stage 2:

- Place a screw fixer into each hole and drill in securely using a battery drill.
- Do not fully tighten the fixers to avoid compressing the adhesive.

For timber installations the strips should be pre-drilled through the anti-slip material. The table below shows the number of drill holes required to allow for the natural contraction and expansion of timber.



b. Concrete Installations

Note: Adhesive only is usually sufficient, however, if adhesive and fixers are preferred, follow the instructions below.

DO NOT use fixers without considering the effects of temperature variance and thermal expansion, especially outdoors. If in doubt contact Ecoglo.

- Position the strip approximately 2-3mm from the front straight edge of the step and using the pre-drilled holes mark where the fixers are to be placed.
- Using a 6mm masonry bit and a concrete drill, drill the hole that will house the plastic anchor.
- Wipe away any dust or debris.
- Place the anchor fully into the holes.
- Apply adhesive as per steps 3-4 taking care to keep adhesive away from the pre-drilled holes.
- Place strip as per steps 5-6.
- Place a screw fixer into each hole and drill in securely using a battery drill.
- Do not fully tighten the fixers to avoid compressing the adhesive.

Hole Drilling Specifications

Hole Drilling Specification	Less than 350mm	350mm - 650mm	650mm - 950mm	950mm - 1250mm	1250mm - 1500mm
Number of Holes	2	3	4	5	6

Holes for fixers are usually drilled as part of manufacturing. If for any reason the product was ordered, or supplied, without holes where fixers are required then Ecoglo recommend the hole spacings shown in the table above for maximum durability.

Step Edge Contrast - E Series Release tape pre-fitted (indoor use only)

And G6-003 Guidance Strips when used on steps

Note: Strips with pre-fitted release tape are suitable only for indoor use on steps which are not subject to daily use or heavy foot traffic. Surfaces must be level and thoroughly prepared.

If any doubts about use, please contact Ecoglo for advice at info@ecoglo.com.

1. Preparation of Surface

- Thoroughly clean the surface with industrial strength cleaner if necessary.
- Remove any loose paint or sealant and then allow surface to dry.
- If painted or coated, check that adhesive is compatible with the paint or seal coating. IF IN DOUBT REMOVE COATING

2. Alignment of the Strips

- Mark 50mm from the left edge of the top step.
- Mark 50mm from the left edge of the bottom step.
- Place a string line between the marks to ensure the strip on each step will be correctly aligned.
- Offer up the strip to the step it is to be attached to make sure both surfaces are parallel.

Note:

The maximum recommended length for installation is 1.5 metres.

Leave a 3mm gap either side of built-in steps.

3. Placement of Adhesive-backed Strip

- Carefully peel off the release-tape backing from the strip.
- Carefully line the strip up with any alignment marks.
- Press the strip firmly in place to ensure even contact between the adhesive tape and the surface to which it is being applied.



Installation Instructions For

Step Nosing F Series

Two-Part Installation Concrete and Timber

Ecoglo markers are to be installed only where there will be sufficient natural or artificial light to keep them charged whenever the building is occupied.

If unsure, contact Ecoglo



1. Preparation of Surface

- Brush the surface clean of dust and debris. If necessary, clean with an industrial cleaner.
- Remove any paint or sealant and then allow the surface to dry.
- It is better for adhesion if timber surfaces are dry.



Steps with exposed sides:

Ensure the nosing is set back from exposed side by at least 20mm to ensure the outer edge of the nosing does not present a sharp hazard.

Built-in steps, Installed outdoors:

Leave a 3mm gap between the nosing and the built-in sides, to allow for thermal expansion, and water drainage.

NOTE: The maximum recommended length for installation in outdoor situations is 1.5 metres. A 3mm expansion / drainage gap must be left between lengths.

2. Alignment (for installation onto more than one step)

- Place one piece of step nosing on the top step and one on the bottom step.
- Run a string line from the left edge of the top nosing to the left edge of the bottom nosing.
- This will give you a straight, true line.



3. Locating Holes for Fixers (for Timber skip to step 5)

- Place the nosing firmly against the riser of the step.
- Line it up with your string line.
- Mark the location of the drill holes with the drill.
- Remove the nosing.

NOTE: F15, F14 and F9 nosings come pre-drilled with holes every 100mm. You only require 4 fixers per metre. Where appropriate, fixers should be zigzagged across the pre-drilled holes to give maximum support to both sides of the nosing.

4. Drilling holes for fixers (for Timber skip to step 5)

- Using a 6mm masonry bit, and a concrete drill, drill the hole that will house the plastic anchor.
- Wipe away any dust or debris.
- Place the plastic anchor fully in to the holes.



5. Applying Adhesive

- Lay a 3mm bead of polyurethane adhesive (such as Wurth KD Bond and Seal or Bostik Seal n Flex FC) in a wave pattern over the full length of the underside of the nosing.
- Keep the adhesive clear of the outside edge and the drill holes.



6. Securing the nosing profile

- Place the nosing firmly back onto the step, lining up the drill holes.
- Tighten the screws firmly using a battery hand drill- this will create a strong, even bond.
- For fixing on to wooden substrate follow the previous instructions but the plugs are not required.

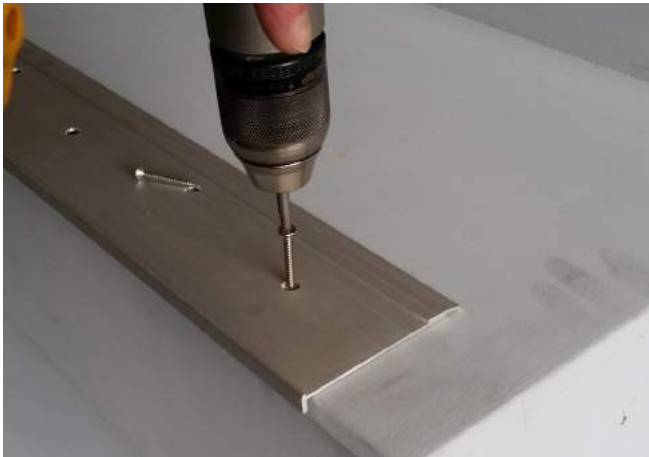

Adhesive Usage:

11 metres per 600ml sausage

Ecoglo supply screw fixers with all orders and can also supply Wurth KD Bond and Seal in 600ml Sausage form with Applicator Gun.

7. Fixing Insert Strip

- Check nosing extrusion channel is free from dust, dirt, grease and moisture.
- Dust or wipe with methylated spirits or damp cloth if required.
- Lay a zigzag of adhesive, 1mm deep, 3mm wide on to the strip.
- Ensure that you don't over apply adhesive as it will spill out once the insert is placed into the nosing.



8. Insert strip into the nosing

- Line up the strip insert then place firmly onto the nosing.
- Press in place to ensure even contact, between the adhesive, and the surface of the channel.
- Use a roller or your foot to apply firm downward pressure.
- Use an alcohol wipe to remove any spill over of adhesive.

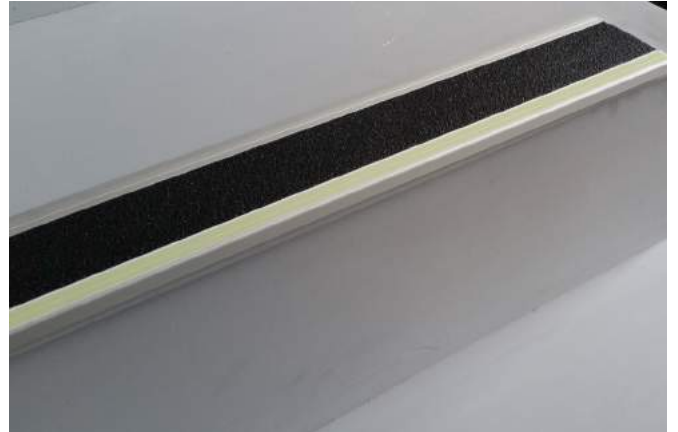

9. Curing of Adhesive

- Allow approximately 24 hours for adhesive to cure.

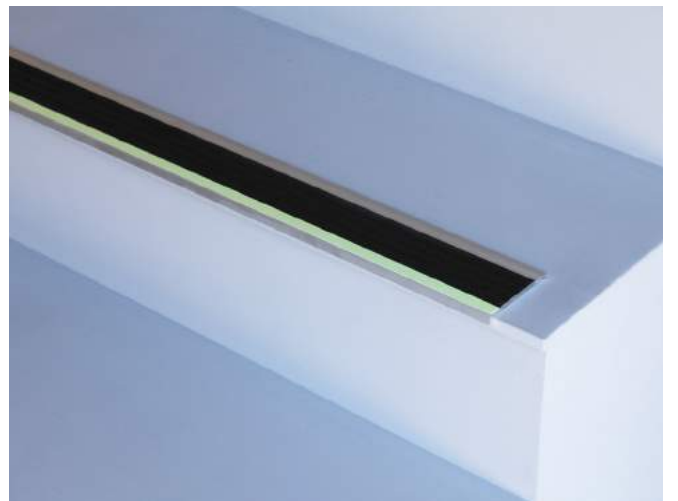

Installation Instructions For

Step Nosing F Series

Concrete and Timber

Ecoglo markers are to be installed only where there will be sufficient natural or artificial light to keep them charged whenever the building is occupied.

If unsure, contact Ecoglo



1. Preparation of Surface

- Brush the surface clean of dust and debris. If necessary, clean with an industrial cleaner.
- Remove any paint or sealant and then allow the surface to dry.
- It is better for adhesion if timber surfaces are dry.



Steps with exposed sides:

Ensure the nosing is set back from exposed side by at least 20mm to ensure the outer edge of the nosing does not present a sharp hazard.

2. Alignment (for installation onto more than one step)

- Place one piece of step nosing on the top step and one on the bottom step.
- Run a string line from the left edge of the top nosing to the left edge of the bottom nosing.
- This will give you a straight, true line.



Built-in steps, Installed outdoors:

Leave a 3mm gap between the nosing and the built-in sides, to allow for thermal expansion, and water drainage.

NOTE: The maximum recommended length for installation in outdoor situations is 1.5 metres. A 3mm expansion / drainage gap must be left between lengths.

3. Locating Holes for Fixers (for Timber skip to step 5)

- Place the nosing firmly against the riser of the step.
- Line it up with your string line.
- Mark the location of the drill holes with the drill.
- Remove the nosing.



4. Drilling holes for fixers (for Timber skip to step 5)

- Using a 6mm masonry bit, and a concrete drill, drill the hole that will house the plastic anchor.
- Wipe away any dust or debris.
- Place the plastic anchor fully in to the holes.



5. Applying Adhesive

- Lay a 3mm bead of polyurethane adhesive (such as Wurth KD Bond and Seal or Bostik Seal n Flex FC) in a wave pattern over the full length of the underside of the nosing.
- Keep the adhesive clear of the outside edge and the drill holes.



Adhesive Usage:

22 metres per 600ml sausage

Ecoglo supply screw fixers with all orders and can also supply Wurth KD Bond and Seal in 600ml Sausage form with Applicator Gun.

6. Fixing the Nosing

- Place the nosing firmly back onto the step, lining up the drill holes.
- Tighten the screws firmly using a battery hand drill- this will create a strong, even bond.
- For fixing on to wooden substrate follow the previous instructions but the plugs are not required.



7. Curing of Adhesive

- Use an alcohol wipe to remove any spill over of adhesive. Allow approximately 24 hours for adhesive to cure.

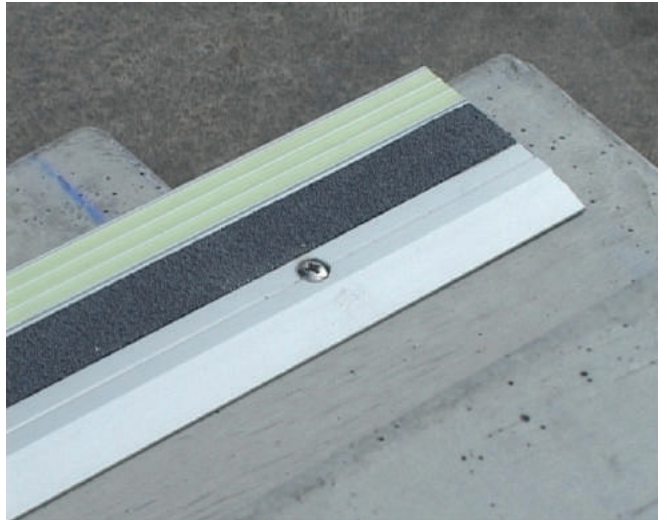

 **ecoglo**[®]
VISIBLY BETTER

Ecoglo International Limited
Email: info@ecoglo.com
www.ecoglo.com



Installation Instructions For

Guidance Strips G Series (Adhesive)

Flat Surfaces

Ecoglo markers are to be installed only where there will be sufficient natural or artificial light to keep them charged whenever the building is occupied.

If unsure, contact Ecoglo



Guidance Strips G-Series Flat Surfaces

Ecoglo G-Series guidance strips are extremely versatile and can be applied on various types of surface, including walls, skirting board, floors, door frames and flat sided handrails. Generally, as long as the substrate is clean, flat and dry the product can be successfully installed.

(If installing on handrails or, if in doubt about adhesion, see Section 8 of these instructions.)

1. Preparation of Surface

- Thoroughly clean the surface with an industrial strength cleaner if necessary.
- Remove any loose paint or sealant and then allow the surface to dry.
- If the surface has been painted or coated, check that adhesive is compatible with the paint or seal coating.
IF IN DOUBT REMOVE COATING.
- Maximum installation length is 1500mm.

2. Positioning, Alignment of the Strips

- If installing on a flat handrail or other surface such as a wall, mark the position where the strip is to be placed. Use a chalkline, plumb-line or spirit level if necessary to ensure the line is straight.
- Offer up the strip to the surface it is to be attached to, to make sure both surfaces are parallel. If the strip does not sit perfectly flat against the surface without being held in place, carefully bend the strip until it sits perfectly flat against the surface.

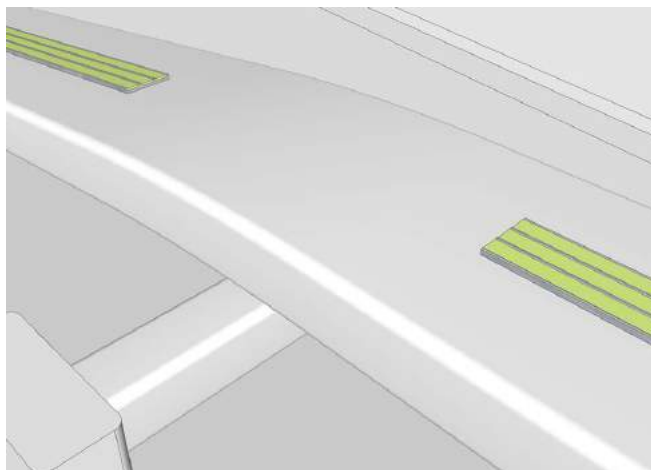
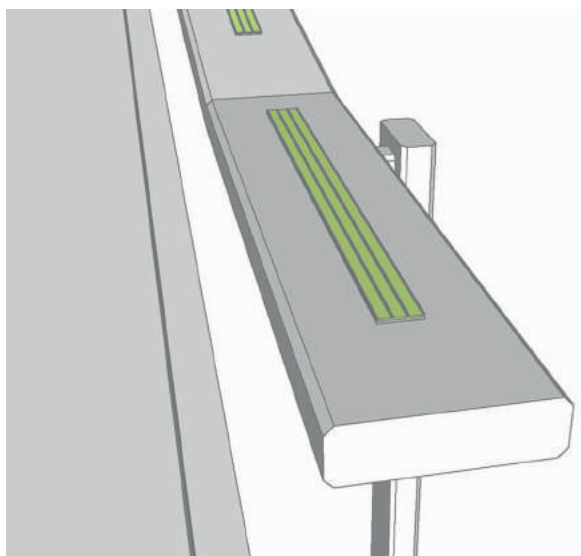

Do not bend guidance strips over bends. Set the strip 50mm from the bend.

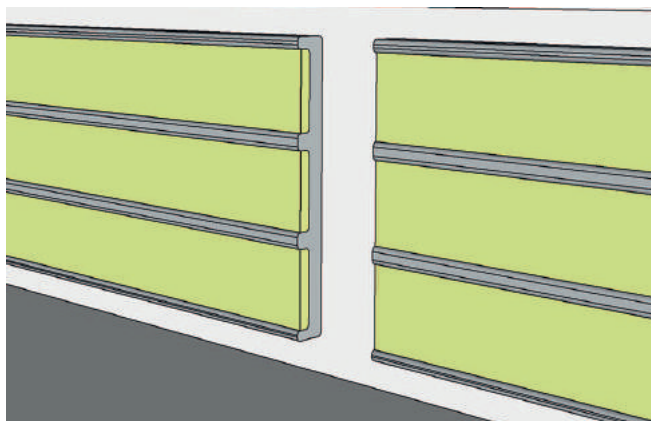

Where strips are to be butted together, there must always be a 3mm expansion gap between them. This allows for expansion and contraction between the Ecoglo strip and the building surface.

3. Preparation of the Strip

- Clean back of the strip with a soft cloth and if necessary use methylated spirits or similar solvent to remove oil or grease.
- Allow to dry for approximately 1 minute.

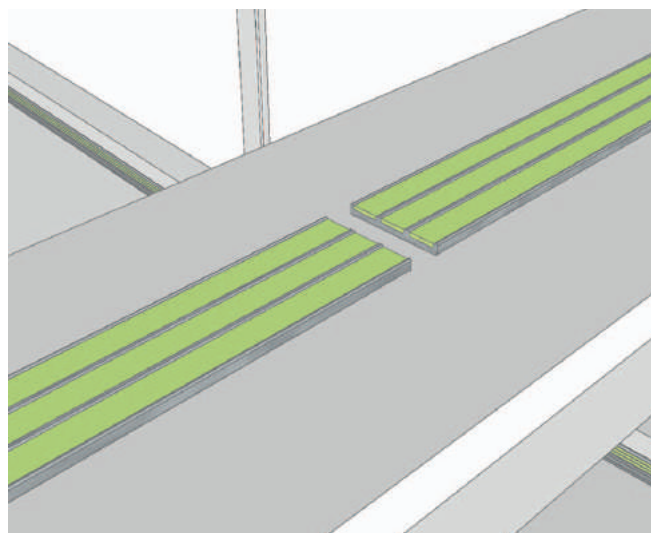

Guidance Strips G-Series Flat Surfaces

Guidance strip can be used to mark corridors, lobbies and indoor lengths of path and can be mounted either on the floor within 100mm of the wall, or on the wall within 100mm of the floor. Gaps of 3mm must be placed between strips.

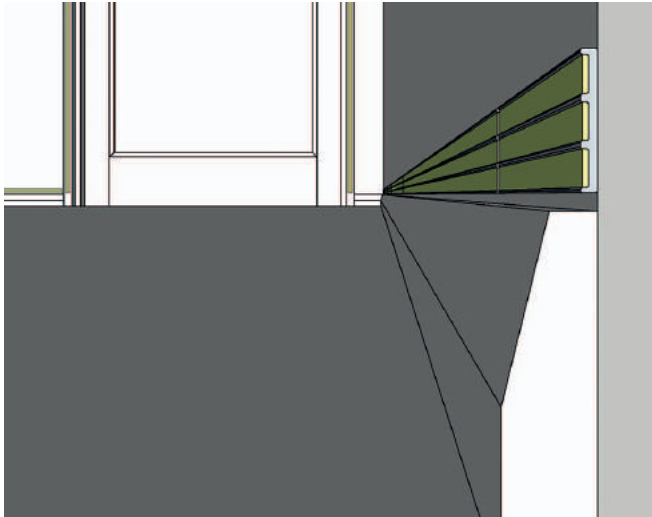

4. Applying the Adhesive

- Apply a 3mm bead of polyurethane adhesive (such as Wurth KD Bond and Seal or Bostik Seal'n'Flex FC) in a wave pattern along the full length of the back of the strip, keeping 3mm in from the edges.

Adhesive Usage: 80 metres per 600ml.

Ecoglo can supply Wurth KD Bond and Seal in 600ml Sausage form with Applicator Gun.

5. Placement of the Strip

- Line up the strip with your alignment marks. Press the strip firmly in place to ensure even contact between the strip and the surface to which it is being applied.

6. Apply Pressure to the Strip

- Apply even pressure to spread the adhesive beneath the strip using a hand roller.

7. Curing of Adhesive

- Use an alcohol wipe to remove any spillover adhesive. Allow approximately 24 hours for adhesive to cure.



For guidance strips on handrails used in schools or public places, screws or rivets must be installed 10 – 15mm in from the end of each strip.

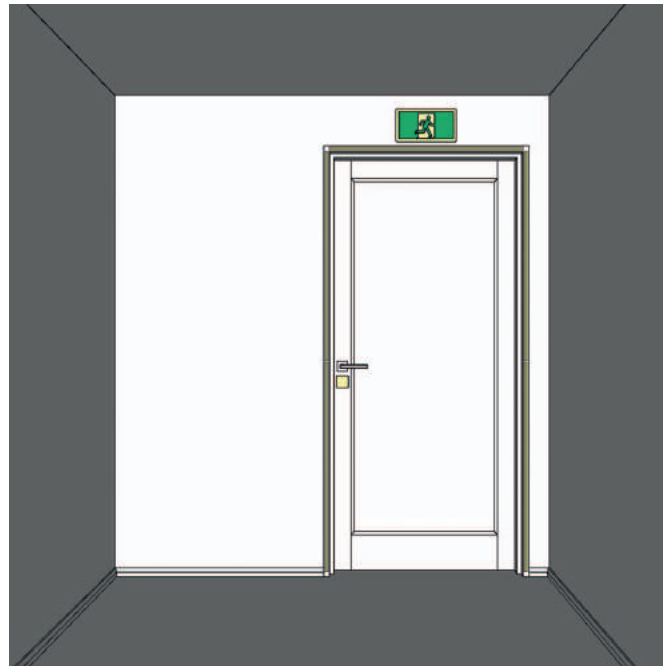

8. Mechanical Fixers (Screws or Rivets)

- Where the strip is used to mark handrails, indoors and outdoors, screws (for timber) or rivets (for metal) MUST also be used. Install one screw/rivet 10-15mm in from each end of each G series strip.
- For outdoor timber installations screws MUST also be used so that the strip isn't able to lift if the timber distorts or absorbs moisture due to normal weather conditions. 5mm pan head screws are suitable to be screwed down firmly. Install one screw 10-15mm in from each end and one screw in the middle of each strip.
- If in doubt about the adhesion of the strips to any substrate, use screws/rivets for additional security. Install one 10-15mm in from each end and one in the middle of each strip.

 **ecoglo**[®]
VISIBLY BETTER

Installation Instructions For

Guidance Strips G Series (Tape)

Flat Surfaces

Ecoglo markers are to be installed only where there will be sufficient natural or artificial light to keep them charged whenever the building is occupied.

If unsure, contact Ecoglo

Guidance Strips G-Series Flat Surfaces

Ecoglo G-Series guidance strips are extremely versatile and can be applied on various types of surface, including walls, skirting board, floors, door frames, flat sided handrails and steps*. Generally, as long as the substrate is clean, flat and dry the product can be successfully installed.

Ecoglo G-Series guidance strips have a self-adhesive backing with a release tape for simple installation. (See Section 4 of these instructions if installing on handrails or, if in any doubt about adhesion).

***Ecoglo G6-003 guidance strips are suitable for use on indoor steps which are not subject to daily use or heavy foot traffic. For outdoor steps, or steps which will be subjected to frequent or heavy foot traffic, visit www.ecoglo.com or contact Ecoglo at info@ecoglo.com for information on more suitable Ecoglo products.**

1. Preparation of Surface

- Thoroughly clean the surface with an industrial strength cleaner if necessary.
- Remove any loose paint or sealant and then allow the surface to dry.
- If the surface has been painted or coated, check that adhesive is compatible with the paint or seal coating.
IF IN DOUBT REMOVE COATING.
- The tape is suitable for a temperature range of 0-40C.
- Maximum installation length is 1500mm.

2. Positioning, Alignment of the Strips

- If installing on a flat handrail or other surface such as a wall, mark the position where the strip is to be placed. Use a chalkline, plumb-line or spirit level if necessary to ensure the line is straight.
- If installing on steps, mark 50mm from the left edge of the top step, and 50mm from the left edge of the bottom step. Place a string line between the marks to ensure the strip on each step will be correctly aligned. This will give a straight, true line.
- Offer up the strip to the surface it is to be attached to, to make sure both surfaces are parallel. If the strip does not sit perfectly flat against the surface without being held in place, carefully bend the strip until it sits perfectly flat against the surface.

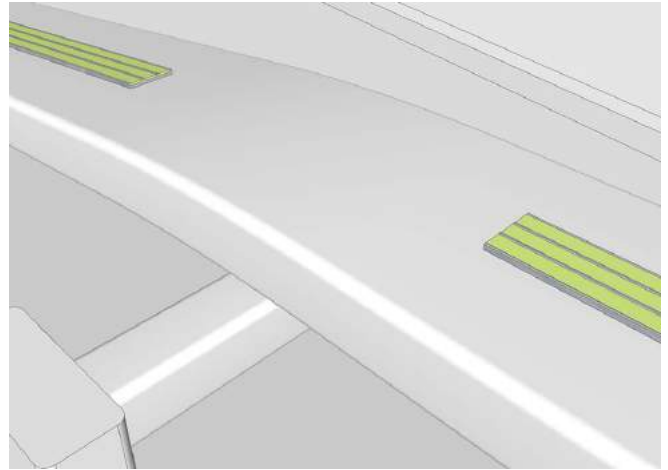
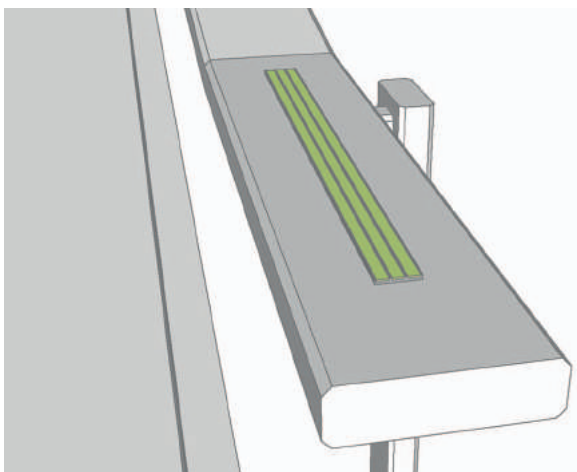

Do not bend guidance strips over bends. Set the strip 50mm from the bend.

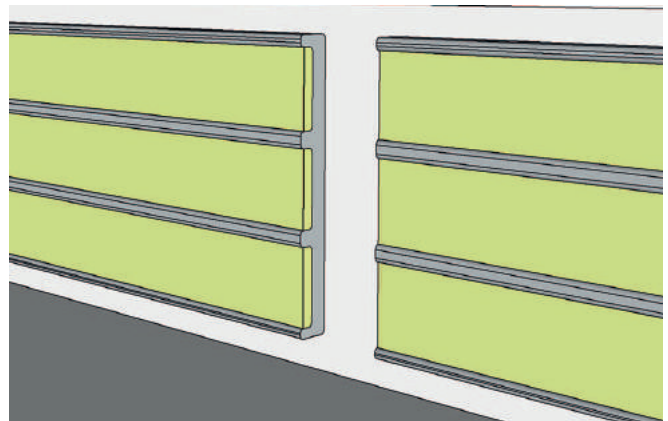

Where strips are to be butted together, there must always be a 3mm expansion gap between them. This allows for expansion and contraction between the Ecoglo strip and the building surface.

3. Placement of Adhesive-backed Strip

- Carefully peel off the release-tape backing from the strip.
- Carefully line the strip up with any alignment marks.
- Press the strip firmly in place to ensure even contact between the adhesive tape and the surface to which it is being applied.

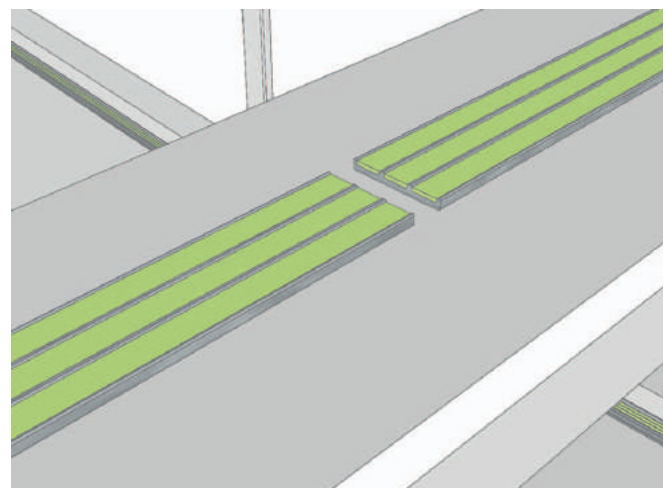

Guidance Strips G-Series Flat Surfaces

Guidance strip can be used to mark corridors, lobbies and indoor lengths of path and can be mounted either on the floor within 100mm of the wall, or on the wall within 100mm of the floor. Gaps of 3mm must be placed between strips.

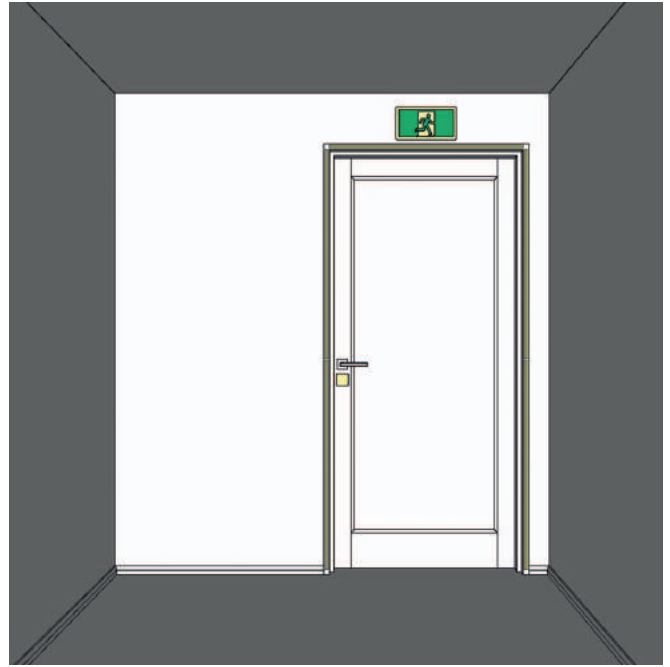
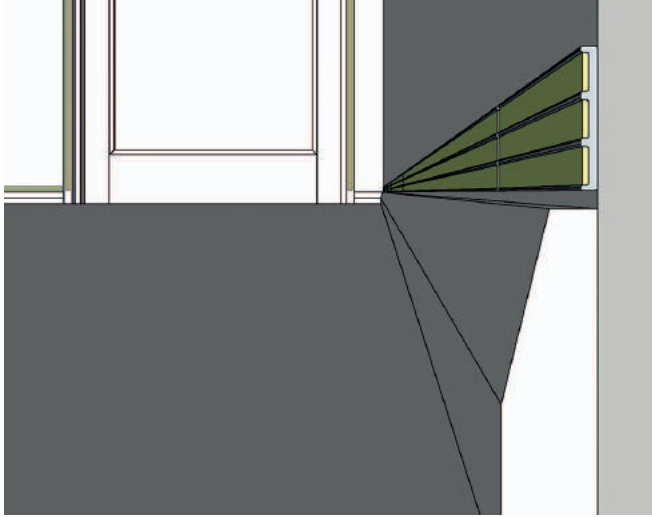

4. Mechanical Fixers (Screws or Rivets)

- Where the strip is used to mark handrails, indoors and outdoors, screws (for timber) or rivets (for metal) **MUST** also be used. Install one screw/rivet 10-15mm in from each end of each G series strip.
- For outdoor timber installations screws **MUST** also be used so that the adhesive tape isn't able to lift if the timber distorts or absorbs moisture due to normal weather conditions. 5mm pan head screws are suitable to be screwed down firmly but not so tight that the tape squashes under the strip. Install one screw 10-15mm in from each end and one screw in the middle of each strip.
- If in doubt about the adhesion of the strips to any substrate, use screws/rivets for additional security. Install one 10-15mm in from each end and one in the middle of each strip.

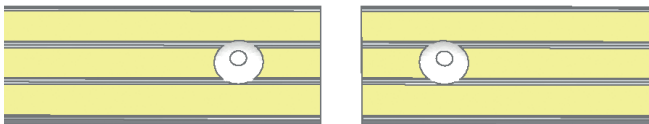

For guidance strips on handrails used in schools or public places, screws or rivets must be installed 10 – 15mm in from the end of each strip.

 **ecoglo**[®]
VISIBLY BETTER

Ecoglo International Limited
Email: info@ecoglo.com
www.ecoglo.com

Installation Instructions For

Handrail H Series

Wall Mounted and Freestanding
Round Handrails

Ecoglo markers are to be installed only where there will be sufficient natural or artificial light to keep them charged whenever the building is occupied.

If unsure, contact Ecoglo



Handrail - H Series Round Handrails

1. Preparation of Surface

- Thoroughly clean the surface with an industrial strength cleaner.
- Remove any loose paint or sealant and then allow the surface to dry.
- Handrail must be dry



2. Alignment

- To ensure the Ecoglo Handrail Strip is installed in line, place a string line, slightly off centre, from the top end of the handrail to the bottom.
- This will serve as a guide for where to place each strip accurately onto the rail.



3. Placing Strip onto Handrail

- Remove the backing paper from the tape
- Line up the outside edge with the string line. The strip should be positioned approximately 50mm from the end of the handrail.
- Press firmly down.
- Repeat the above steps for the full length of the handrail leaving a 3mm gap between each length of handrail.



- If the overall length of the handrail is longer than 1 metre as supplied, then the 1 metre lengths should be placed at each end of the handrail and a separate unit should be measured and cut for the middle section.
- Following any cutting of the product, ensure edges are filed smooth and rounded.



4. Mechanical Fixers (screws or rivets)

- In all installations, indoor and outdoor, screws (for timber) or rivets (for metal) MUST also be used. Install one screw/rivet 10-15mm in from each end of each H series strip.
- For outdoor timber installations 5mm pan head screws are suitable. Screw down firmly but not so tight that the tape squashes under the strip. Install one screw 10-15mm in from each end and one screw in the middle of each H series strip.

Note: Flat Handrails

- Ecoglo G3-001 or G6-003 can be used on indoor handrails that have flat tops. The same method of installation applies.



Note: Under no circumstances, should handrail product be installed on or around a curve. This includes bends at each end of the handrail.

Installation Instructions For

Path Markers T-Series

Concrete and Timber

Ecoglo markers are to be installed only where there will be sufficient natural or artificial light to keep them charged whenever the building is occupied.

If unsure, contact Ecoglo



Path Markers T-Series Concrete and Timber

1. Preparation of Surface

- Thoroughly clean the surface with industrial strength cleaner if necessary.
- Remove any loose paint or sealant and then allow surface to dry.
- If painted or coated check that the adhesive is compatible with the paint or seal coating*. IF IN DOUBT REMOVE COATING.

Note: Installation onto Concrete Surfaces

It is important to use adhesive only for concrete installations. The adhesive will allow some movement to compensate for thermal contraction and expansion and will provide durable adhesion to the concrete substrate.

* Where adhesive only installation is preferred on surfaces that have a sealer applied (eg exposed aggregate and some tiles) a test patch should be laid and allowed to temperature cycle over a minimum of 14 days to ensure a good bond is achieved.

If the adhesive does not hold then mechanical fixers should be used. If mechanical fixing is not practical due to potential damage to the substrate please contact Ecoglo.

2. Alignment of the Path Markers

- Mark the position where the path marker is to be placed using a chalk line if necessary to ensure the line is straight.

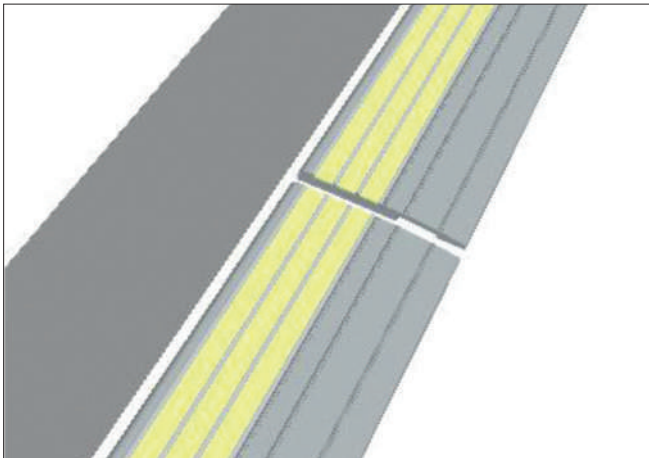

Note: The Path Markers come in 1m lengths. A 3mm expansion/drainage gap must be left between lengths. Markers can be cut with a hand-saw or drop-saw to suit.

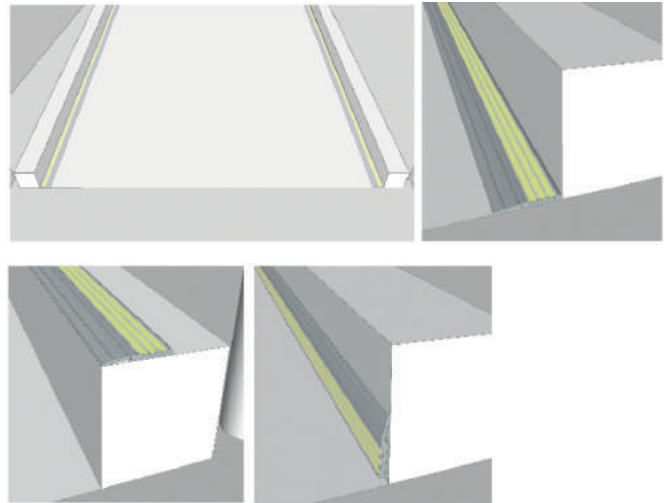

The Path Marker installed in various positions on a ramp.

3. Timber Installation

- Place the path marker in position, lining it up with any markings.
- Pre-drill a pilot hole in the timber if necessary.
- Tighten the screws firmly using a battery drill.

4. Concrete Installation

- Lay a 3mm bead of polyurethane adhesive (either Wurth KD Bond and Seal or Bostik Seal n Flex FC) in a wave pattern over the full length of widest part on the underside of the marker.
- Place the path marker firmly onto the substrate ensuring it is straight.

Adhesive Usage:

- T5-101 - 25 metres per 600ml
- T6-101 - 30 metres per 600ml

Ecoglo can supply Wurth KD Bond and Seal in 600ml Sausage form with Applicator Gun.

5. Curing of Adhesive

- Use an alcohol wipe to remove any spillover of adhesive.
- Allow approximately 24 hours for adhesive to cure.

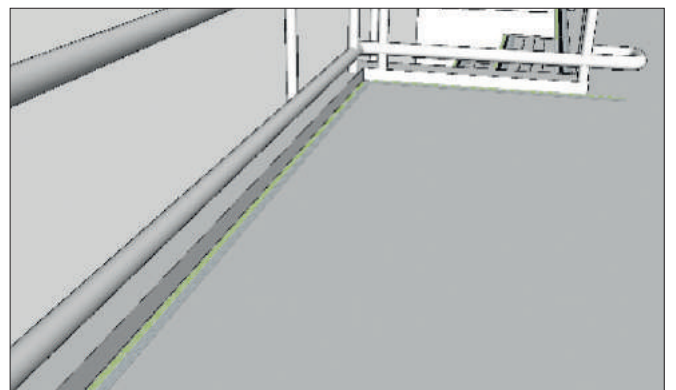

The Path Marker installed adjacent to wall.



Installation Instructions For

Hazard Tape UL-HZ2518

Flat Surfaces

Ecoglo markers are to be installed only where there will be sufficient natural or artificial light to keep them charged whenever the building is occupied.

If unsure, contact Ecoglo

Ecoglo International Limited
Email: info@ecoglo.com
www.ecoglo.com



Installation Instructions for Hazard Tape UL-HZ2518

Ecoglo recommended UL-HZ2518 Hazard Tape can be installed successfully on most clean, dry, smooth surfaces. Common applications for the hazard tape include obstacles, pipes, and firefighting equipment which extends into the egress path.

Note: This tape is for indoor use only.

Users should test the tape in a small area for suitability and satisfactory adherence to the installation surface prior to completing full installation.

Preparation of Surface

- The installation surface **MUST** be smooth.
- Thoroughly clean the surface with an industrial strength cleaner, if necessary, to remove any surface contaminants such as dust, dirt, grease etc.
- Loose paint must be removed from painted surfaces.
- Allow the surface to dry.
- If the surface has been painted or coated, check that adhesive is compatible with the paint or seal coating.

Application

Applying the photoluminescent hazard tape

- **Do not stretch the tape when applying to the installation surface.**
- Apply the hazard tape by removing a few centimetres of the liner and pressing the tape to the installation surface.
- Firmly roll or rub the tape in the direction which it is being applied, removing as much liner as is required to complete installation.
- Repeat rubbing or rolling as necessary to ensure that the tape has completely conformed to the surface.

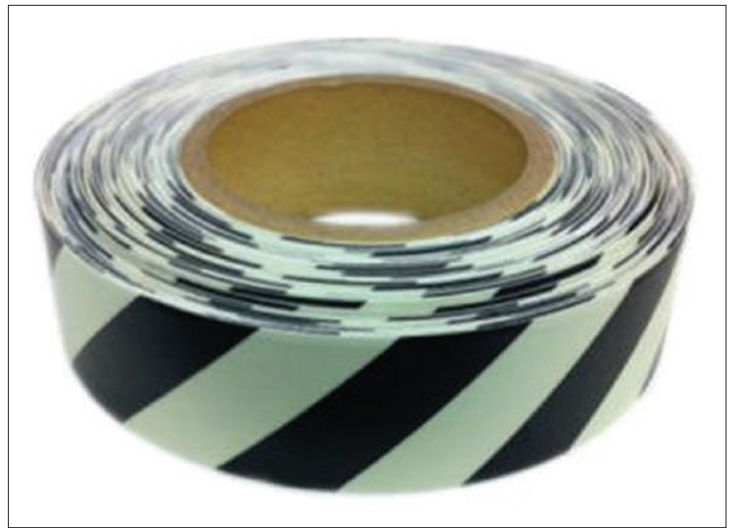



Installation Instructions For

Signs (Pre-fitted release tape)

(Including Floor Identification Signs and Door Handle Markers)

Surface Mounted Signs

Ecoglo signs are to be installed only where there will be sufficient natural or artificial light to keep them charged whenever the building is occupied.

If unsure, contact Ecoglo

Ecoglo International Limited
Email: info@ecoglo.com
www.ecoglo.com

Installation Instructions for Signs (Pre-fitted release tape)

1. Preparation of Surface

- Thoroughly clean the surface with industrial strength cleaner if necessary.
- Remove any loose paint or sealant then allow surface to dry.

2. Positioning of Signs

- Mark position on the door or wall where sign is to be placed.

Note:

Floor Identification signs – the mounting height must be in accordance with local and national codes.

3. Placement of Signs

- Peel the protective layer from the back of the sign to expose the adhesive ensuring nothing comes into contact with it.
- Line the sign up with the markings you made.
- Apply pressure evenly over the sign to fix it fast to the surface.

4. Maintenance of Signs

- Regular dusting with a soft cloth or brush is recommended to keep the sign clean.
- If the sign is noticeably dirty, clean with a sponge or cloth.

See Cleaning Instructions for more detailed information.

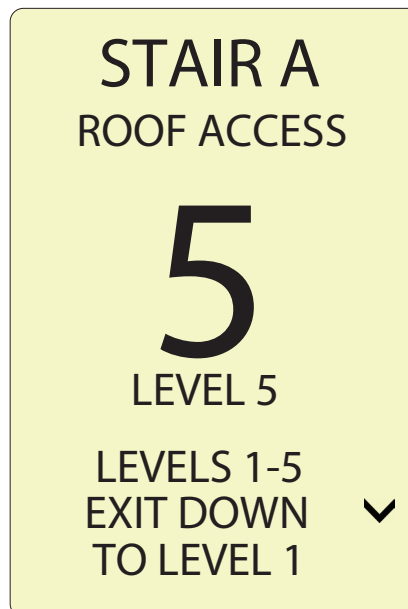



Installation Instructions For

Door Push Bar Marker UL-DHM3840

Flat Surfaces

Ecoglo markers are to be installed only where there will be sufficient natural or artificial light to keep them charged whenever the building is occupied.

If unsure, contact Ecoglo

Ecoglo International Limited
Email: info@ecoglo.com
www.ecoglo.com



Installation Instructions for Door Push Bar Marker

UL-DHM3840



Ecoglo recommended UL-DHM3840 Door Push Bar Marker comes pre-fitted with release tape, making installation a simple process.

Note: This marker is for indoor use only.

1. Surface preparation

- The installation surface MUST be smooth.
- Thoroughly clean the surface with an industrial strength cleaner, if necessary, to remove any surface contaminants such as dust, dirt, grease etc.
- Loose paint must be removed from painted surfaces.
- Allow the surface to dry.
- If the surface has been painted or coated, check that adhesive is compatible with the paint or seal coating.

2. Application

- If necessary, mark the position on the push bar where the Door Push Bar Marker is to be placed.
- Carefully peel off the release-tape backing from the marker.
- Line the marker up with any alignment marks made.
- Press the marker firmly in place to ensure even contact between the adhesive tape and the push bar.



Appendix 3

Ecoglo International Ltd

Product Test Reports for Photoluminescent Emergency Visibility

MasterFormat Section 10 45 00
- Photoluminescent Exit Specialties

Contents	Page
UL 410 Standard for Slip Resistance of Floor Surface Materials	79
AS4586-2013, Slip Resistance Classification of New Pedestrian Surface Materials	89
ASTM G155-04 Cycle 1 1000 hours, Standard Practice for Operating Xenon Arc Light Apparatus for Exposure of Nonmetallic Metals	93
ASTM B117-97 500 hours, Standard Practice for Salt Spray (Fog) Apparatus	96
ASTM D4828-94 (2003), Standard Test Methods for Practical Washability of Organic Coatings	97
ASTM D635-03, Standard Test Method for Rate of Burning and/or Extent and Time of Burning Plastics in a Horizontal Position	98
ASTM D3648-2004, Standard Practices for the Measurement of Radioactivity	99
ASTM E162-02, Standard Test Method for Surface Flammability of Materials Using a Radiant Heat Energy Source	100
Bombardier Toxic Gas Generation Test SMP800-C	102
UL 1994 Standard for Luminous Egress Path Marking Systems	105
Luminance Measurements of Photoluminescent Materials after 1 Hour Activation Period	117
High Temperature Curing (HTC) Test (based on AS/NZS 1580.481.1)	120



February 17, 2020

MR. DELWYN RALSTON
Ecoglo International Ltd.
77 Kingsley St.
Christchurch, 8023
New Zealand

Subject: Preliminary Investigation, Project 4789277791, testing samples to determine their average and individual static coefficients of friction has been completed.

Dear Mr. Delwyn Ralston:

UL has completed the testing for Step Edge Contrast Models E2-071, E2071, E2-061, E2061, E2-051, E2051, E2-031, E2031, E3-071, E3071, E3-061, E3061, E3-051, E3051, E3-031, E3031, E4-071, E4071, E4-061, E4061, E4-051, E4051, E4-031, E4031, E4-073, E4073, E4-063, E4063, E4-053, E4053, E4-033, E4033, E14-075, E14075, E14-065, E14065, E14-055, E14055, E14-035, E14035, E15-073, E15073, E15-063, E15063, E15-053, E15053, E15-033, E15033, E15-075, E15075, E15-065, E15065, E15-055, E15055, E15-035, E15035, G6-003, G6003, G5-001, G5001, G6-001, G6001, G6-070, G6070, G6-060, G6060, G6-050, G6050, G6-030, G6030, N2-070, N2070, N2-060, N2060, N2-050, N2050, N2-030, N2030, N3-070, N3070, N3-060, N3060, N3-050, N3050, N3-030, N3030 for UL 410 Walkway Construction Material (WCM) used as floor surface materials, provided by Ecoglo International Ltd, using the James Machine, which tests the static friction of a surface. I have attached the written report indicating the test results for the individual static coefficients of friction for each sample supplied. Models: E4-073, E14-75, G6-003 were used for test purposes and considered representative of all other models above.

Note: Samples were not selected by UL and the project will not result in a UL Certification nor will the product be eligible to bear the UL Mark based on these test results. The testing is Ecoglo International Ltd. research use only.

This completes our work for project 4789277791 and you will receive an invoice for the specified cost limit of \$2800.00 for the project.

Any information and documentation involving UL Mark services are provided on behalf of UL LLC (UL) or any authorized licensee of UL.

Please contact us with any questions
Aaron Messinger
Engineering Project Handler
Furniture and Furnishings Business Division

UL Verification Services Inc.
3480 Windquest Drive
Holland, MI 49424
T: 1-(616)294-5421

Number of pages in this package 9

CLIENT INFORMATION	
Company Name	ECOGLO INTERNATIONAL LTD.
Address	77 Kingsley St Christchurch, 8023 New Zealand

AUDIT INFORMATION:			
Description of Tests	Per Standard No.	UL 410	Edition/ Revision Date
			Third Dated October 25, 2006
[X] Tests Conducted by +			
	Aaron Messinger		<i>Aaron J. Messinger</i>
	Printed Name		Signature
[] UL Staff witnessing testing (WTDP only)			
[] Authorized Signatory (CTDP, TPTDP, TCP)			
	Printed Name		Signature, and include date for CTDP, TPTDP, TCP
Reviewed and accepted by qualified Project Handler			
	Printed Name		Signature

[] The following tests conducted in accordance with UL 410 were considered representative of the same tests required by Canadian Standard, _____.

TESTS TO BE CONDUCTED:			
Test No.	Done	Test Name	[] Comments/Parameters [] Tests Conducted by ++
1	01/29/2020	SLIP RESISTANCE CHARACTERISTICS: WCM	

Instructions -

- 1 - When all tests are conducted by one person, name can be inserted here instead of including name on each page containing data.
- 2 - When test conducted by more than one person, name of person conducting the test can be inserted next to the test name instead of including name on each page containing data. Test dates may be recorded here instead of entering test dates on the individual datasheet pages.
- 3 - Indication of compliance is optional. See the datasheet for each test for compliance.
- 4 - Link to separate data files for a test can be inserted here. The link must be to a server that is accessible to UL staff, that provides for backup, required retention periods and a path, including file name that does not change and result in a broken link. Not applicable to DAP.

If noncompliant test results are obtained, provide this data to a qualified project handler for further processing.

Special Instructions -

Unless specified otherwise in the individual Methods, the tests shall be conducted under the following ambient conditions. Confirmation of these conditions shall be recorded at the time the test is conducted.

Ambient Temperature, C 23 ± 2 Relative Humidity, % 50 ± 4 Barometric Pressure, mBar ±

No general environmental conditions are specified in the Standard(s) or have been identified that could affect the test results or measurements.

RISK ANALYSIS RELATED TO TESTING PERFORMANCE:

The following types of risks have been identified. Take necessary precautions. This list is not all inclusive.

<input type="checkbox"/> Electric shock	<input type="checkbox"/> Radiation
<input type="checkbox"/> Energy related hazards	<input type="checkbox"/> Chemical hazards
<input type="checkbox"/> Fire	<input type="checkbox"/> Noise
<input type="checkbox"/> Heat related hazards	<input type="checkbox"/> Vibration
<input type="checkbox"/> Mechanical	<input checked="" type="checkbox"/> Other (Specify) Slip Resistance

TEST LOCATION: (To be completed by Staff Conducting the Testing)	
<input checked="" type="checkbox"/> UL or Affiliate	<input type="checkbox"/> WTDP <input type="checkbox"/> TPTDP
Company Name: UL Verification Services.	
Address: Holland MI.	

TEST EQUIPMENT INFORMATION

UL test equipment information is recorded on Meter Use.

UL test equipment information is recorded on <<insert location and local laboratory equipment system identification.>>

Inst. ID No.	Instrument Type	Test Number +, Test Title or Conditioning	Function /Range	Last Cal. Date	Next Cal. Date

+ - If Test Number is used, the Test Number must be identified on the data sheet pages or on the Data Sheet Package cover page.

The following additional information is required when using client's or rented equipment. The Inst. ID No. below corresponds to the Inst. ID No. above.

Inst. ID No.	Make/Model/Serial Number/Asset No.

Test equipment information is recorded on UL's Laboratory Project Management (LPM)/Laboratory Equipment Management (LEM) database. (This statement may be selected only if datasheets are completed electronically at a UL facility).

TEST SAMPLE IDENTIFICATION:

The table below is provided to provide correlation of sample numbers to specific product related information. Refer to this table when a test identifies a test sample by "Sample No." only.

Sample Card No.	Date Received	[] Test No.	Sample No.	Manufacturer, Product Identification and Ratings
283399	01/28/2020	1	1	ECOGLO INTERNATIONAL LTD, PL Path Marking Models G6-003 Alternate Model Names G6003, G5-001, G5001 WCM

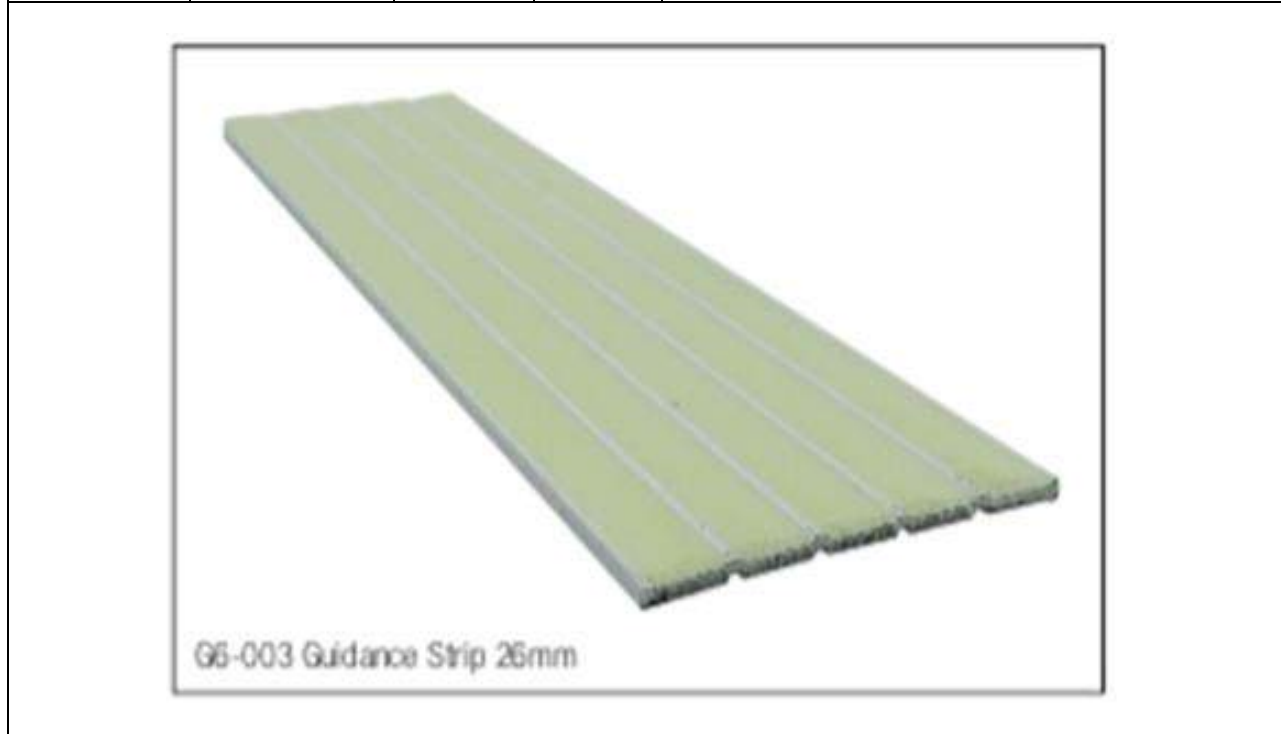

+ - If Test Number is used, the Test Number or Numbers the sample was used in must be identified on the data sheet pages or on the Data Sheet Package cover page.

[] Sampling Procedure -

SLIP RESISTANCE CHARACTERISTICS: (WCM)

WCM Material: **Model G6-003**

METHOD

[X] A sample of the material was tested as received after it was brushed or wiped clean to remove any surface contaminants.

[X] Additionally, a second sample of the material was tested after belt sanding with 1/2 (60) grit aluminum oxide paper for 1 minute and brushed or wiped clean to remove surface contaminants.

The slip resistance characteristics of the material were measured in accordance with the established and standardized practice of UL LLC and in accordance with the latest edition of the Standard for Slip Resistance of Floor Surface Materials, UL 410.

RESULTS

(As received)

Sample Orientation	Coefficient of Friction
First Quadrant	0.59
Adjacent Quadrant	0.54
180 degrees from First Quadrant	0.60
180 degrees from Adjacent Quadrant	0.54
Average	0.56

[X] The average static coefficient of friction of the four quadrants of the test sample **[was]** ~~[was not]~~ at least 0.50 and the individual static coefficients of friction **[was]** ~~[was not]~~ at least 0.45.

SLIP RESISTANCE CHARACTERISTICS: (WCM) (CONT'D)

WCM Material: Model E4-073

wide

(Belt Sanded)

Sample Orientation	Coefficient of Friction
First Quadrant	0.55
Adjacent Quadrant	0.68
180 degrees from First Quadrant	0.57
180 degrees from Adjacent Quadrant	0.69
Average	0.62

[X] The average static coefficient of friction of the four quadrants of the test sample **[was]** ~~[was not]~~ at least 0.50 and the individual static coefficients of friction **[was]** ~~[was not]~~ at least 0.45.

Note to Lab:

If the minimum and maximum run values vary by greater than 0.06, please re-conduct the test. If the second set minimum and maximum values vary greater than 0.06, please contact the engineer.

Slip Resistance Test Conditions

AMBIENT TEMPERATURE **23.2°C** Relative Humidity **49.6%**

SLIP RESISTANCE CHARACTERISTICS: (WCM)

WCM

Material: Model E14-075

METHOD

[X] A sample of the material was tested as received after it was brushed or wiped clean to remove any surface contaminants.

[X] Additionally, a second sample of the material was tested after belt sanding with 1/2 (60) grit aluminum oxide paper for 1 minute and brushed or wiped clean to remove surface contaminants.

The slip resistance characteristics of the material were measured in accordance with the established and standardized practice of UL LLC and in accordance with the latest edition of the Standard for Slip Resistance of Floor Surface Materials, UL 410.

RESULTS

(As received)

Sample Orientation	Coefficient of Friction
First Quadrant	0.64
Adjacent Quadrant	0.56
180 degrees from First Quadrant	0.68
180 degrees from Adjacent Quadrant	0.52
Average	0.60

[X] The average static coefficient of friction of the four quadrants of the test sample **[was]** ~~[was not]~~ at least 0.50 and the individual static coefficients of friction **[was]** ~~[was not]~~ at least 0.45.

SLIP RESISTANCE CHARACTERISTICS: (WCM) (CONT'D)

Material: Model E14-075

(Belt Sanded)

Sample Orientation	Coefficient of Friction
First Quadrant	0.55
Adjacent Quadrant	0.53
180 degrees from First Quadrant	0.52
180 degrees from Adjacent Quadrant	0.55
Average	0.53

[X] The average static coefficient of friction of the four quadrants of the test sample **[was]** ~~[was not]~~ at least 0.50 and the individual static coefficients of friction **[was]** ~~[was not]~~ at least 0.45.

Note to Lab:

If the minimum and maximum run values vary by greater than 0.06, please re-conduct the test. If the second set minimum and maximum values vary greater than 0.06, please contact the engineer.

Slip Resistance Test Conditions

AMBIENT TEMPERATURE **22.5°C** Relative Humidity **49.1%**

Project No. 4789277791
LABORATORY DATA PACKAGE

File SA45391

Page 9
Date _____

END OF DATASHEET PACKAGE. THIS PAGE INTENTIONALLY LEFT BLANK

ULS-00410-IMET-DataSheet-2001
Form Page 9

Form Issued: 2002-10-28
Form Revised: 2012-05-16

Copyright © 2012 UL LLC

Only those products bearing the UL Mark should be considered as being covered by UL.

Client:	Ecoglo Pte Ltd	Client Job No:	
Project:	Submitted Samples	Order No:	
Location:		Tested Date:	7/09/2021
SGS Job Number:	21-01-1318	Sample No:	21-MT-6389
Lab:	Perth Laboratory	Sample ID:	E14-075

Slip Resistance Classification of New Pedestrian Surface Materials

AS4586 App A - Wet Pendulum Method

Tile Identification:	E14-075
Cleaning Performed:	None
Type of Test:	Specimen Unfixed
Rubber Slider	96
Tested By:	MLT

Mean BPN	
Test No.: 1	68
Test No.: 2	67
Test No.: 3	68
Test No.: 4	68
Test No.: 5	68

MEAN BRITISH PENDULUM NUMBER: 68

CLASSIFICATION: P5

Temperature At Test: 23 °C

Note: Sample supplied by client - tested as received.

This test report covers the following Product Range:

E14 Photoluminescent & Non-Slip Strip, 51.0mm width with 51.0mm wide of Non-Slip and 12.6mm wide of PL.
E14-035, E14-055, E14-065, E14-075, and E14-085

This Certificate replaces the previously issued Certificate No.:21-MT-6389-B400/1

Authorised Signatory:  (Michael TIMLIN)

Date: 10/09/2021



Accreditation No.: 2418
Accredited for compliance with ISO/IEC 17025 - Testing

Client Address: 111 North Bridge Rd #17-06 Peninsula Plaza 179098

Site No.: 2411
Cert No.: 21-MT-6389-B400/2
Form No.RP-AU-INDCMT-TE-B400 V10.0

Client:	Ecoglo Pte Ltd	Client Job No:	
Project:	Submitted Samples	Order No:	
Location:		Tested Date:	7/09/2021
SGS Job Number:	21-01-1318	Sample No:	21-MT-6390
Lab:	Perth Laboratory	Sample ID:	E15-073

Slip Resistance Classification of New Pedestrian Surface Materials

AS4586 App A - Wet Pendulum Method

Tile Identification:	E15-075
Cleaning Performed:	None
Type of Test:	Specimen Unfixed
Rubber Slider	96
Tested By:	MLT

Mean BPN	
Test No.: 1	76
Test No.: 2	79
Test No.: 3	80
Test No.: 4	78
Test No.: 5	76

MEAN BRITISH PENDULUM NUMBER: 78

CLASSIFICATION: P5

Temperature At Test: 23 °C

Note: Sample supplied by client - tested as received.

This test report covers the following Product Range:

E15 Photoluminescent & Non-Slip Strip, 51.0mm width with 37.3mm wide of Non-Slip and 26.3mm wide of PL.
E15-033, E15-053, E15-063, E15-073 and E15-083

This Certificate replaces the previously issued Certificate No.:21-MT-6390-B400/1

Authorised Signatory:  (Michael TIMLIN)

Date: 10/09/2021



Accreditation No.: 2418
Accredited for compliance with ISO/IEC 17025 - Testing

Client Address: 111 North Bridge Rd #17-06 Peninsula Plaza 179098

Site No.: 2411
Cert No.: 21-MT-6390-B400/2
Form No.RP-AU-INDCMT-TE-B400 V10.0

Client:	Ecoglo Pte Ltd	Client Job No:	
Project:	Submitted Samples	Order No:	
Location:		Tested Date:	7/09/2021
SGS Job Number:	21-01-1318	Sample No:	21-MT-6388
Lab:	Perth Laboratory	Sample ID:	E3-071

Slip Resistance Classification of New Pedestrian Surface Materials

AS4586 App A - Wet Pendulum Method

Tile Identification:	E3-071
Cleaning Performed:	None
Type of Test:	Specimen Unfixed
Rubber Slider	96
Tested By:	MLT

Mean BPN	
Test No.: 1	67
Test No.: 2	66
Test No.: 3	67
Test No.: 4	67
Test No.: 5	67

MEAN BRITISH PENDULUM NUMBER: 67

CLASSIFICATION: P5

Temperature At Test: 21 °C

Note: Sample supplied by client - tested as received.

This test report covers the following Product Range:

E3 Photoluminescent & Non-Slip Strip, 51.0mm width with 33.5mm wide of Non-Slip and 15.5mm wide of PL.
E3-031, E3-051, E3-061, E3-071, and E3-081

This Certificate replaces the previously issued Certificate No.:21-MT-6388-B400/1

Authorised Signatory:  (Michael TIMLIN)

Date: 10/09/2021



Accreditation No.: 2418
Accredited for compliance with ISO/IEC 17025 - Testing

Site No.: 2411
Cert No.: 21-MT-6388-B400/2
Form No.RP-AU-INDCMT-TE-B400 V10.0

Client Address: 111 North Bridge Rd #17-06 Peninsula Plaza 179098

Client:	Ecoglo Pte Ltd	Client Job No:	
Project:	Submitted Samples	Order No:	
Location:		Tested Date:	7/09/2021
SGS Job Number:	21-01-1318	Sample No:	21-MT-6391
Lab:	Perth Laboratory	Sample ID:	N3-070

Slip Resistance Classification of New Pedestrian Surface Materials

AS4586 App A - Wet Pendulum Method

Tile Identification:	N3-070
Cleaning Performed:	None
Type of Test:	Specimen Unfixed
Rubber Slider	96
Tested By:	MLT

Mean BPN	
Test No.: 1	82
Test No.: 2	79
Test No.: 3	81
Test No.: 4	84
Test No.: 5	82

MEAN BRITISH PENDULUM NUMBER: 82

CLASSIFICATION: P5

Temperature At Test: 23 °C

Note: Sample supplied by client - tested as received.

This test report covers the following Product Range:

N3 Non-Slip Strip, 51.0mm width with 51.0mm wide of Non-Slip.

N3-030, N3-050, N3-060, N3-070, and N3-080

This Certificate replaces the previously issued Certificate No.:21-MT-6391-B400/1

Authorised Signatory:  (Michael TIMLIN)

Date: 10/09/2021

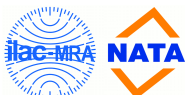

Accreditation No.: 2418
Accredited for compliance with ISO/IEC 17025 - Testing

Site No.: 2411
Cert No.: 21-MT-6391-B400/2
Form No.RP-AU-INDCMT-TE-B400 V10.0

Client Address: 111 North Bridge Rd #17-06 Peninsula Plaza 179098



SINCE 1886

REPORT



3933 US ROUTE 11 CORTLAND, NEW YORK 13045

Order No. 3078911

Date: November 15, 2005

REPORT NO. 3078911CRT-006

TEST OF FOUR PHOTOLUMINESCENT MATERIAL MODELS

RENDERED TO

ECOGLO LTD.
77 KINGSLEY ROAD
CHRISTCHURCH, NEW ZEALAND 8002

DATA REQUESTED

Luminance measurements after activation tests on four photoluminescent material models after UV exposure in accordance with New York City Building Code Reference Standards RS 6-1 and RS 6-1A: Photoluminescent Low-level Exit Path Markings.

AUTHORIZATION

This test service was authorized by signed quote number 18761099.

DEVICES SUBMITTED

The client submitted three photoluminescent material samples each of four Models: G3001C/E2071C, and G5001C/H5001C. The samples were received by Intertek on June 18, 2005 in undamaged condition, and tested as received. The sample designations are E2218Z through E2223Z.

DATE OF TESTS

June 28, 2005 through November 13, 2005.

TEST SUMMARY

NYC Building Code RS 6-1A Photoluminescent Low-level Exit Path Markings	Model G3001C/E2071C	Model G5001C/H5001C
Clause 1.0 Brightnes Rating Post UV Exposure	Complies	Complies

An independent organization testing for safety, performance, and certification.

This report is for the exclusive use of Intertek's Client and is provided pursuant to the agreement between Intertek and its Client. Intertek's responsibility and liability are limited to the terms and conditions of the agreement. Intertek assumes no liability to any party, other than to the Client in accordance with the agreement, for any loss, expense or damage occasioned by the use of this report. Only the Client is authorized to copy or distribute this report and then only in its entirety. Any use of the Intertek name or one of its marks for the sale or advertisement of the tested material, product or service must first be approved in writing by Intertek. The observations and test results in this report are relevant only to the sample tested. This report by itself does not imply that the material, product, or service is or has ever been under an Intertek certification program. Measurement uncertainty budgets have been determined for applicable test methods and are available upon request.

EQUIPMENT LIST

Equipment Used	Model Number	Control Number	Calibration Date
Optronic Luminance Standard	455-6-2	Y174	09/30/04
Optronic based Luminance Meter consisting of:			
Optronic Photometer	730C	E290	06/23/05
Optronic Direct Viewing Module	600	---	---
Optronic Amplified Photodetector	730-5H-LED	---	---
Fisher Scientific Stopwatch	---	N853	05/05
UDT Illumination Meter	S371R	L060	09/02/04

TEST AND TEST METHODSelective Process

After evaluation at Intertek, it was determined that Models G3001C and E2071C are identical in regards to luminance performance and that Models G5001C and H5001C are identical in regards to luminance performance.

Luminance Measurements Before and After Weathering Test

The luminance measurements were made on the photoluminescent test samples with the Intertek License Plate Test Apparatus. The center of each test sample was measured at normal (0°) viewing angle. The aperture of the Optronic based luminance meter was adjusted in order to view the maximum area on the test sample. The Intertek License Plate Test Apparatus consists of a Optronic based luminance meter and a horizontal and vertical movement system. The luminance calibration of the luminance meter is traceable to the National Institute of Standards and Technology through the calibration of the Optronic Luminance Standard.

The test samples were conditioned for at least 16 hours at zero footcandle illumination. The photoluminescent material samples were then conditioned for 120 minutes (two hours) by 2 footcandle illumination from a 4100K fluorescent light source. Luminance measurements were made on each test sample at two minutes intervals after conditioning for a period of one hour and at ninety minutes after conditioning. Luminance measurements were reported for ten minutes, sixty minutes and ninety minutes after conditioning.

Weathering Tests

The test samples were sent to Canesis Network Limited for 1000 hours exposure to Xenon Arc light apparatus per ASTM G155 Cycle 1. The samples were returned to Intertek for the post UV luminance measurements. Average post UV luminance measurements must be at least 90% of the initial average luminance measurements at each time interval.

Checked by: 

RESULTS OF TESTLuminance Measurements After Two Hours Activation Period

Model No. G5001C/H5001C
Intertek Sample Nos. E2220Z, E2218Z, E2219Z
 Luminance (mcd/m²)

Time After Exposure	Sample One	Sample Two	Sample Three	Average	Specified Minimum
<u>Pre UV Exposure</u>					
Ten Minutes	41.1	40.8	42.3	41.4	30
One Hour	9.96	9.66	10.25	9.96	7.0
Ninety Minutes	6.56	6.37	6.78	6.57	5.0
<u>Post UV Exposure</u>					
Ten Minutes	37.6	37.5	36.9	37.3	37.3*
One Hour	10.09	9.54	10.19	9.94	8.96*
Ninety Minutes	6.97	6.41	7.02	6.80	5.91*

Model No. G3001C/E2071C
Intertek Sample Nos. E2222Z, E2221Z, E2223Z
 Luminance (mcd/m²)

Time After Exposure	Sample One	Sample Two	Sample Three	Average	Specified Minimum
<u>Pre UV Exposure</u>					
Ten Minutes	105.6	104.7	107.3	105.9	30
One Hour	29.0	28.5	29.2	28.9	7.0
Ninety Minutes	20.2	19.7	20.1	20.0	5.0
<u>Post UV Exposure</u>					
Ten Minutes	99.1	97.2	100.0	98.8	95.3*
One Hour	27.3	28.4	27.6	27.8	26.0*
Ninety Minutes	18.1	19.4	18.4	18.6	18.0*

* Specified minimum is 90% of average initial luminance value at each time interval

In Charge Of Tests:

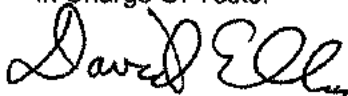

David Ellis
 Project Engineer
 Photometric Testing

Report Reviewed By:



Ernest Dykeman
 Senior Project Engineer
 Photometric Testing

Attachment: None



Scientific Services
Laboratory

Report No: XC2278/R1

TEST REPORT
SALT SPRAY TESTING OF STAIR NOSING

File: BPB/MISC

1. SAMPLE DETAILS

Client: Delwyn Ralston
LincLab Ltd
Private Bag 4749
Christchurch New Zealand

Sample Details: Five samples of aluminium stair nosings with anti-slip and photoluminescence inserts.

Requirements: To determine the salt spray resistance on the stair nosing.

2 TEST DETAILS-NATA REGISTRATION 219

2.1 Salt Spray

The samples were exposed in a Singleton Model 21 Salt Spray Cabinet for 500 hours. A second sample of 120201 J was kept as a reference sample. The salt spray testing was carried out in accordance with ASTM B117-97 'Standard Test Method of Salt Spray (Fog) Testing'.

2.2 Evaluation

After exposure, the samples were evaluated in accordance with ASTM D1654-92 'Evaluation of Painted or Coated Specimens Subject to Corrosive Environment'. The degree of corrosion was determined in accordance with ASTM D610. The anti-slip properties were assessed visually at 10 x magnification. The photoluminescence of the exposed samples was compared with that of the reference sample in a dark room.

3 RESULTS

Sample No	XC 2278/F	XC 2278/G	XC 2278/H	XC 2278/I	XC 2278/J
Details	Aluminium stair nosing Labelled 120201F	Aluminium stair nosing Labelled 120201G	Aluminium stair nosing Labelled 120201H	Aluminium stair nosing Labelled 120201I	Aluminium stair nosing Labelled 120201J
Degree of Corrosion	0.5 % (Rating 9)	0.3 % (Rating 9)	0.3 % (Rating 9)	0.2 % (Rating 9)	0.2 % (Rating 9)
Anti Slip Properties	No deterioration observed	No deterioration observed	No deterioration observed	No deterioration observed	No deterioration observed
Photo - luminescence	No deterioration observed	No deterioration observed	No deterioration observed	No deterioration observed	No deterioration observed

G. Eccleston

G Eccleston
Senior Materials Scientist
9 April 2001



National Association of Testing
Authorities, Australia

NATA Endorsed Test Report
This document may not be
reproduced except in full.

AS/NZS ISO 9001 Quality System Certified Organisation

177 Salmon St, Port Melbourne, Vic, 3207 Telephone (03) 9248 4900 Fax (03) 9646 5165
A Business Unit of the Australian Government Analytical Laboratories (AGAL)
Industry, Science and Resources



TEST REPORT

DATE: 07/07/2005

TEST NUMBER: 096346

CLIENT	Ecoglo Ltd
--------	------------

TEST METHOD CONDUCTED	ASTM D4828 Washability of Organic Materials
-----------------------	---

DESCRIPTION OF TEST SAMPLE	
IDENTIFICATION	E2071
COLOR	Photoluminescent
ROLL	-----
CONSTRUCTION	-----
FIBER	-----
BACKING	-----
REFERENCE	

GENERAL PRINCIPLE

This test method covers the determination of the relative ease of removal of common soil and stains from interior coatings. The stains used in this procedure include: crayon, pen, lipstick, and 3M soil. The soilants are applied to the material and are subsequently removed manually using a sponge and liquid cleaner. The area stained is rated for color change and the number of cleaning cycles reported at the point of complete removal. Three replicates of each stain were applied with the results reported as the average of all three ratings.

TEST RESULTS

	Crayon	Felt Tip Pen	Lipstick	3M soil
Gloss Change	None	None	None	None
Color Change	None	None	None	None
Erosion	None	None	None	None
Cycles to Clean	74	7	31	14
Rating	10	10	10	10

NOTE: This sample **PASSES** the requirements as listed in the New York Department of Buildings RS6-1A section 6-1A 2.0

APPROVED BY:

This report is provided for the exclusive use of the client to whom it is addressed. It may be used in its entirety to gain product acceptance from duly constituted authorities. This report applies only to those samples tested and is not necessarily indicative of apparently identical or similar products. This report, or the name of Professional Testing Laboratory Inc. shall not be used under any circumstance in advertising to the general public.



TEST REPORT

DATE: 07/07/2005

TEST NUMBER: 096346

CLIENT	Ecoglo Ltd
--------	------------

TEST METHOD CONDUCTED	ASTM D635 Standard Test Method for Rate of Burning and or Extent and Time of Burning of Self-Supporting Plastics in a Horizontal Position
-----------------------	---

DESCRIPTION OF TEST SAMPLE	
IDENTIFICATION	E2071
COLOR	Photoluminescent
ROLL	-----
CONSTRUCTION	-----
FIBER	-----
BACKING	-----
REFERENCE	

GENERAL PRINCIPLE

This method covers a small scale procedure for comparing the relative rate of burning and the extent and time of burning of self-supporting plastics that are tested in the horizontal position. A bar of the material is supported at one end. The free end is exposed to a gas flame for 30 seconds. The time and extent of burning are measured and reported. An average burn rate is reported over ten test specimens.

TEST RESULTS

	Burn Rate	Time of Burn	Extent of Burn
Specimen 1	No Burn Rate	0 Seconds	Did Not Ignite
Specimen 2	No Burn Rate	0 Seconds	Did Not Ignite
Specimen 3	No Burn Rate	0 Seconds	Did Not Ignite
Specimen 4	No Burn Rate	0 Seconds	Did Not Ignite
Specimen 5	No Burn Rate	0 Seconds	Did Not Ignite
Specimen 6	No Burn Rate	0 Seconds	Did Not Ignite
Specimen 7	No Burn Rate	0 Seconds	Did Not Ignite
Specimen 8	No Burn Rate	0 Seconds	Did Not Ignite
Specimen 9	No Burn Rate	0 Seconds	Did Not Ignite
Specimen 10	No Burn Rate	0 Seconds	Did Not Ignite
Average	No Burn Rate	0 Seconds	Did Not Ignite

APPROVED BY:

This report is provided for the exclusive use of the client to whom it is addressed. It may be used in its entirety to gain product acceptance from duly constituted authorities. This report applies only to those samples tested and is not necessarily indicative of apparently identical of similar products. This report, or the name of Professional Testing Laboratory Inc. shall not be used under any circumstance in advertising to the general public.

CALIFORNIA INSTITUTE OF ELECTRONICS AND MATERIALS SCIENCE
 2115 Flame Tree Way, Hemet, CA 92545 • Phone: 951 929 2659; Fax: 951 929 1057 • www.ciems.com

JALITE USA P. O. No. APR 15 of APRIL 15, 2005

DIVISION OF ELECTRONIC MEASUREMENTS AND DEVICES

Page 1 of 2

TEST REPORT
 NO. 850850821B of 20 MAY 2005

BRIGHTNESS, RADIOACTIVITY AND FLAME SPREAD TEST

Table 1. LUMINANCE TEST (Contact Method)

No.	Sample	Tested Area Geometry		Excitation		Luminance (Brightness), mcd/m ² after the time period of		
		Diameter mm	Area cm ²	Duration min	Illuminance lx	10 min	60 min	90 min
1	Ecoglo-G3001c	56.39	25.0	120.0	21.63	111	28.8	19.7

CONCLUSION: *1. The tested samples of Ecoglo-G3001c meet the requirements of NYC Building Code Ref. STD RS 6-1, para. 1.4.*
2. The material tested has the Brightness Rating of 111-29-20.

Table 2. RADIOACTIVITY TEST

No.	Material	Test Result, μ Sv/hr			Comments
		α -count	β -count	γ -count	
1 radioactive	Ecoglo-G3001c	<0.01	<0.01	<0.01	Non-

CONCLUSION: *The tested samples of Ecoglo-G3001c meet the requirements of NYC Building Code Ref. STD RS 6-1, para. 4.2.*

(continued on page 2)

3. FLAME SPREAD TEST

No.	Material	Test Parameters		Flame Spread	Flame Spread	Comments
		Temperature Drop $\Delta T, K$	Spec. Temperature Rise, $\beta, K/kW$	Factor, F_s 1	Index, I_s 1	
1	Ecoglo-G3001c	21.5	31.4	1.51	7.59	Ignites with difficulties

CONCLUSION: *The tested samples of Ecoglo-G3001c meet the requirements of NYC Building Code Ref STD RS 6-1, para. 5.2.*

TEST DESCRIPTION

- The test per ISO 17398:2000, Clause 7.11 and NYC BC Ref. STD RS-1, para. 1.1 - 1.4 (brightness); ASTM D3648 and NYC BC Ref. STD RS-1, para. 4.1 - 4.2 (radioactivity); and ASTM E162 and NYC BC Ref. STD RS 6-1, para. 5.1 - 5.2 (flame spread). Test conditions: T=22°C, RH=47±2%, P=101.0±0.2 kPa.
- The samples were preconditioned for the luminance test in the dark chamber and being wrapped in the black photographic paper for 63 hours, and were removed from the chamber immediately before the test. The test was performed in the windowless room lighted with the red photo-processing light. The excitation fluorescent light source has the maximum equivalent radiation intensity of $1.94 \cdot 10^7 \text{ W/m}^2$ ($4.3 \cdot 10^3 \text{ K}$) with $\lambda_{\text{max}}=674 \text{ nm}$.
- The radiation intensity readings were taken at nine different points on the surface of each of the samples tested with the samples located inside and outside of the radiation insulation chamber and under twelve angles between the normal to the sample surface and the direction of the field of gravity. The data in Table 2 were processed to exclude both the cosmic and the earth radiation background noise.
- The experimental error evaluated by the partial derivatives and least squares methods does not exceed 5%, 4% and 6.5% for the luminance, radioactivity and flame spread measurements, respectively. The data on the standard deviation are kept on file at CIEMS.

5. INSTRUMENTS AND DEVICES USED

- Digital Photometer Model 840006 SSL (0 to 20,000 lx), Digital Scotopic/Photopic Meter Model SL-3101 SLC
- Radiometer/Photometer Model DR-2000 w/Si Detector GS
- Goniometer Model 3501-08 FD
- Moseley X-Y Recorder Model 7035B HP
- 50A, 6V Stabilized Power Supply Model SC-506FAVD HBC
- Precision Micrometer Model 25/100 Krupp/Hommelwerke
- Radiation Pyrometer Model ST-30 Raynger
- Digital Timer Model Labchron-1402 LLI
- Programmed Temperature/Humidity Controller Model 100
- Geiger-Mueller Counter Model SGM-49C PRI

(continued on page 3)

- Scintillator Counter Model 111 PRI
 - Digital Nuclear Radiation Monitor Model DX-1 ITS
 - Flame Spread Testing Device Model 394-19DI BD
 - Digital Pyrometer Model Metis-MP25 SensorTherm GmbH (100°C - 700°C, 2.0 µm - 2.8 µm)
 - Optical Pyrometer Model MX-2 Raytek
 - IR Thermometer Model IR550 DKS
 - Precision Potentiometer/Thermometer Model 8659-AZ L&N
 - Microscopes: Model 9700 TSC, Model 500 PH, Model Tukon-300 Wilson
 - Starrett Dial Indicator Model 25-109 (1.27 µm/div)
 - Digital Hydrothermometer Model 63-844 MI, Barometer Model 602650 SB.
6. Reference materials used for the test setup calibration:
- NIST SRM 4233C (Cs-137-Ba-137m) - for the radiation measurements
 - NIST SRM 1002d ($I_s=153$, $Q=36.5$) - for the flame spread test.
7. The equipment used in the test meets the applicable NIST, ASTM, ASME, OSHA and State requirements and was calibrated with the standards traceable to the NIST. The calibration was performed per ANSI/ISO ASQ Q9004-2000, ISO 10012-1:1992, ISO 10012-2:1997, MIL-STD-45662, MIL-I-45208, NAVAIR-17-35-MTL-1, CSP-1/03-93 and the instruments manufacturers' specifications.
8. The equipment passed a periodic accuracy test in June 2004. The linear and volume measure instruments and equipment were calibrated in December 2004. Next test - June 2005.

TEST ENGINEER: 51

DIVISION MANAGER: *Cynthia Smythe*



BODYCOTE • 2395 SPEAKMAN DRIVE, MISSISSAUGA, ONTARIO, CANADA L5K 1B3 • TEL: (905) 822-4111 • FAX: (905) 823-1446

Bombardier SMP 800-C Toxic Gas Generation on "Ecoglo E2071" HPPL Composite

A Report To: **Professional Testing Laboratory, Inc.**
714 Glenwood Place
Dalton, GA 30721
USA

Phone: (706) 226-3283
Fax: (706) 226-6787

Attention: Lee Phillips

Submitted By: Fire Testing

Report No. 05-02-519
3 pages + 1 appendix

Date: July 12, 2005

ACCREDITATION Standards Council of Canada, Registration #1.

REGISTRATIONS

- ISO 9001:2000, registered by QMI, Registration #001109.
- New York City Department of Buildings, MEA Division, Registration #110-05-L.

SPECIFICATIONS OF ORDER

Determine toxic gas production according to Bombardier SMP 800-C, as per your P.O. #2005-062905 dated June 29, 2005.

IDENTIFICATION (BMTC sample identification number 05-02-S0519)

Composite, abrasive strip and high performance photoluminescent (HPPL) material on aluminum tracking substrate, approximately 2.1 to 2.4 mm in total thickness, identified as "Ecoglo E2071".

SAMPLE PREPARATION

Specimens were supplied as a two-material composite strip with two separate, and compositionally different materials attached to an aluminum tracking substrate. Since this strip represents the final product, it was determined that this test procedure was appropriate. Requisite specimen sizes were created by butting two strips of the material together vertically in the specimen holders, in alternate stripes, in an attempt to offer maximum exposure to both materials.



Far Left. Composite marking system shown as supplied (cut to length).

Right: Test specimen (2 sections butted together vertically) shown in sample holder with abrasive strip and HPPL ridges alternating.

TEST RESULTS

Bombardier SMP 800-C

Toxic Gas Generation

		Flaming <u>Mode</u>	Non-Flaming <u>Mode</u>	Specified <u>Maxima</u>
Carbon Monoxide (CO ppm)	at 1.5 minutes	<10	<10	-
	at 4.0 minutes	10	<10	-
	at maximum	463	<10	3500
Carbon Dioxide (CO2 ppm)	at 1.5 minutes	<50	<50	-
	at 4.0 minutes	1850	<50	-
	at maximum	13400	<50	90000

TEST RESULTS (Cont..)

Bombardier SMP 800-C

Toxic Gas Generation

	<u>Flaming Mode</u>	<u>Non-Flaming Mode</u>	<u>Specified Maxima</u>
Nitrogen Oxides (as NO2 ppm)	2	1	100
Sulfur Dioxide (SO2 ppm)	<1	<1	100
Hydrogen Chloride (HCl ppm)	7	9	500
Hydrogen Fluoride (HF ppm)	<2	<2	100
Hydrogen Bromide (HBr ppm)	<1	<1	100
Hydrogen Cyanide (HCN ppm)	2	<1	100
Original Weight (g) (including substrate)	24.8	24.4	-
Final Weight (g) (including substrate)	<u>20.9</u>	<u>24.2</u>	-
Weight Loss (g)	3.9	0.2	-
Weight Loss (%)	15.86	0.78	-
Time to Ignition (s)	125	Did not ignite	-
Burning Duration (s)	Not determinable	-	-

CONCLUSIONS

The photoluminescent composite material on aluminum identified in this report, when tested at a total approximate thickness of 2.1 to 2.4 mm, meets Bombardier requirements as they pertain to toxic gas production (Bombardier SMP 800-C) and therefore meets the toxicity requirements of paragraph 3.0 of the New York City Building Code § 27-383(b) Reference Standard RS 6-1A (Photoluminescent exit path markings).

Note: This is an electronic copy of the report. Signatures are on file with the original report.

I. Smith,
Fire Testing.

Richard J. Lederle,
Fire Testing.

Note: This report consists of 3 pages, including the cover page, that comprise the report "body". It should be considered incomplete if all pages are not present. Additionally, the Appendix of this report comprises a cover page, plus 1 page.

CERTIFICATE OF COMPLIANCE

Certificate Number UL-US-L45151-11-03109102-1
Report Reference SA45151-20190130
Date 13-Sep-2021

Issued to: Ecoglo International Ltd
77 Kingsley St Christchurch
New Zealand 8023

This is to certify that representative samples of IMZI - Luminous Egress-path-marking Systems
See Addendum Page for Product Designation(s).

Have been investigated by UL in accordance with the Standard(s) indicated on this Certificate.

Standard(s) for Safety: UL 1994, 4th Ed., Issue Date: 2015-05-29

Additional Information: See the UL Online Certifications Directory at <https://iq.ulprospector.com> for additional information

This Certificate of Compliance does not provide authorization to apply the UL Mark. Only the UL Follow-Up Services Procedure provides authorization to apply the UL Mark.

Only those products bearing the UL Mark should be considered as being UL Certified and covered under UL's Follow-Up Services.

Look for the UL Certification Mark on the product.

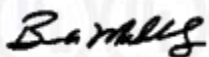

Bruce Mahrenholz, Director North American Certification Program

UL LLC

Any information and documentation involving UL Mark services are provided on behalf of UL LLC (UL) or any authorized licensee of UL. For questions, please contact a local UL Customer Service Representative at <http://ul.com/aboutul/locations/>



CERTIFICATE OF COMPLIANCE

Certificate Number UL-US-L45151-11-03109102-1
Report Reference SA45151-20190130
Date 13-Sep-2021

This is to certify that representative samples of the product as specified on this certificate were tested according to the current UL requirements

Model	Category Description
E14-035	Photoluminescent Floor proximity egress path marking systems
E14-055	Photoluminescent Floor proximity egress path marking systems
E14-065	Photoluminescent Floor proximity egress path marking systems
E14-075	Photoluminescent Floor proximity egress path marking systems
E15-073	Photoluminescent Floor proximity egress path marking systems
E2-031	Photoluminescent Floor proximity egress path marking systems
E2-051	Photoluminescent Floor proximity egress path marking systems
E2-061	Photoluminescent Floor proximity egress path marking systems
E2-071	Photoluminescent Floor proximity egress path marking systems
E2031	Photoluminescent Floor proximity egress path marking systems
E2051	Photoluminescent Floor proximity egress path marking systems
E2061	Photoluminescent Floor proximity egress path marking systems
E2071	Photoluminescent Floor proximity egress path marking systems
E3-031	Photoluminescent Floor proximity egress path marking systems
E3-051	Photoluminescent Floor proximity egress path marking systems
E3-061	Photoluminescent Floor proximity egress path marking systems
E3-071	Photoluminescent Floor proximity egress path marking systems
E3031	Photoluminescent Floor proximity egress path marking systems
E3051	Photoluminescent Floor proximity egress path marking systems

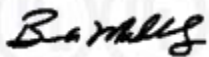

Bruce Mahrenholz, Director North American Certification Program

UL LLC

Any information and documentation involving UL Mark services are provided on behalf of UL LLC (UL) or any authorized licensee of UL. For questions, please contact a local UL Customer Service Representative at <http://ul.com/aboutul/locations/>



CERTIFICATE OF COMPLIANCE

Certificate Number UL-US-L45151-11-03109102-1
Report Reference SA45151-20190130
Date 13-Sep-2021

E3061	Photoluminescent Floor proximity egress path marking systems
E3071	Photoluminescent Floor proximity egress path marking systems
E4-031	Photoluminescent Floor proximity egress path marking systems
E4-033	Photoluminescent Floor proximity egress path marking systems
E4-051	Photoluminescent Floor proximity egress path marking systems
E4-053	Photoluminescent Floor proximity egress path marking systems
E4-061	Photoluminescent Floor proximity egress path marking systems
E4-063	Photoluminescent Floor proximity egress path marking systems
E4-071	Photoluminescent Floor proximity egress path marking systems
E4-073	Photoluminescent Floor proximity egress path marking systems
E4031	Photoluminescent Floor proximity egress path marking systems
E4051	Photoluminescent Floor proximity egress path marking systems
E4061	Photoluminescent Floor proximity egress path marking systems
E4071	Photoluminescent Floor proximity egress path marking systems
G3-001	Photoluminescent Floor proximity egress path marking systems
G3001	Photoluminescent Floor proximity egress path marking systems
G4-001	Photoluminescent Floor proximity egress path marking systems
G4001	Photoluminescent Floor proximity egress path marking systems
G5-001	Photoluminescent Floor proximity egress path marking systems
G5001	Photoluminescent Floor proximity egress path marking systems
G6-001	Photoluminescent Floor proximity egress path marking systems
G6-003	Photoluminescent Floor proximity egress path marking systems
G6001	Photoluminescent Floor proximity egress path marking systems

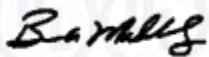

Bruce Mahrenholz, Director North American Certification Program

UL LLC

Any information and documentation involving UL Mark services are provided on behalf of UL LLC (UL) or any authorized licensee of UL. For questions, please contact a local UL Customer Service Representative at <http://ul.com/aboutul/locations/>



CERTIFICATE OF COMPLIANCE

Certificate Number UL-US-L45151-11-03109102-1
Report Reference SA45151-20190130
Date 13-Sep-2021

H3-001	Photoluminescent Floor proximity egress path marking systems
H3001	Photoluminescent Floor proximity egress path marking systems
H5-001	Photoluminescent Floor proximity egress path marking systems
H5-003	Photoluminescent Floor proximity egress path marking systems
H5001	Photoluminescent Floor proximity egress path marking systems
S5-ARD1010	Photoluminescent Floor proximity egress path marking systems
S5-ARS1010	Photoluminescent Floor proximity egress path marking systems
S5-DHM1010	Photoluminescent Floor proximity egress path marking systems
S5-RM2010	Luminous Egress-Path-Marking Systems
S5-RMDA2010	Luminous Egress-Path-Marking Systems
S5-RMDL2010	Luminous Egress-Path-Marking Systems
S5-RMDR2010	Luminous Egress-Path-Marking Systems
S5-RML2010	Luminous Egress-Path-Marking Systems
S5-RMR2010	Luminous Egress-Path-Marking Systems
S5-RMUA2010	Photoluminescent Floor proximity egress path marking systems
S5-RMUL2010	Luminous Egress-Path-Marking Systems
S5-RMUR2010	Luminous Egress-Path-Marking Systems

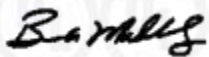

Bruce Mahrenholz, Director North American Certification Program

UL LLC

Any information and documentation involving UL Mark services are provided on behalf of UL LLC (UL) or any authorized licensee of UL. For questions, please contact a local UL Customer Service Representative at <http://ul.com/aboutul/locations/>



CERTIFICATE OF COMPLIANCE

Certificate Number UL-CA-L45151-21-03109102-1
Report Reference SA45151-20190130
Date 13-Sep-2021

Issued to: Ecoglo International Ltd
77 Kingsley St Christchurch
New Zealand 8023

**This is to certify that
representative samples of**

IMZI7 - Luminous Egress-path-marking Systems Certified
for Canada

See Addendum Page for Product Designation(s).

Have been investigated by UL in accordance with the
Standard(s) indicated on this Certificate.

Standard(s) for Safety: ULC S572, 2nd Ed., Issue Date: 2017-02-01

Additional Information: See the UL Online Certifications Directory at
<https://iq.ulprospector.com> for additional information

This Certificate of Compliance does not provide authorization to apply the UL Mark. Only the UL Follow-Up Services Procedure provides authorization to apply the UL Mark.

Only those products bearing the UL Mark should be considered as being UL Certified and covered under UL's Follow-Up Services.

Look for the UL Certification Mark on the product.

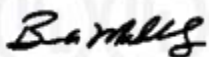

Bruce Mahrenholz, Director North American Certification Program

UL LLC

Any information and documentation involving UL Mark services are provided on behalf of UL LLC (UL) or any authorized licensee of UL. For questions, please contact a local UL Customer Service Representative at <http://ul.com/aboutul/locations/>



CERTIFICATE OF COMPLIANCE

Certificate Number UL-CA-L45151-21-03109102-1
Report Reference SA45151-20190130
Date 13-Sep-2021

This is to certify that representative samples of the product as specified on this certificate were tested according to the current UL requirements

Model	Category Description
E14-035	Photoluminescent Floor proximity egress path marking systems
E14-055	Photoluminescent Floor proximity egress path marking systems
E14-065	Photoluminescent Floor proximity egress path marking systems
E14-075	Photoluminescent Floor proximity egress path marking systems
E15-073	Photoluminescent Floor proximity egress path marking systems
E2-031	Photoluminescent Floor proximity egress path marking systems
E2-051	Photoluminescent Floor proximity egress path marking systems
E2-061	Photoluminescent Floor proximity egress path marking systems
E2-071	Photoluminescent Floor proximity egress path marking systems
E2031	Photoluminescent Floor proximity egress path marking systems
E2051	Photoluminescent Floor proximity egress path marking systems
E2061	Photoluminescent Floor proximity egress path marking systems
E2071	Photoluminescent Floor proximity egress path marking systems
E3-031	Photoluminescent Floor proximity egress path marking systems
E3-051	Photoluminescent Floor proximity egress path marking systems
E3-061	Photoluminescent Floor proximity egress path marking systems
E3-071	Photoluminescent Floor proximity egress path marking systems
E3031	Photoluminescent Floor proximity egress path marking systems
E3051	Photoluminescent Floor proximity egress path marking systems

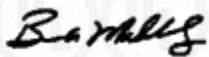

Bruce Mahrenholz, Director North American Certification Program

UL LLC

Any information and documentation involving UL Mark services are provided on behalf of UL LLC (UL) or any authorized licensee of UL. For questions, please contact a local UL Customer Service Representative at <http://ul.com/aboutul/locations/>



CERTIFICATE OF COMPLIANCE

Certificate Number UL-CA-L45151-21-03109102-1
Report Reference SA45151-20190130
Date 13-Sep-2021

E3061	Photoluminescent Floor proximity egress path marking systems
E3071	Photoluminescent Floor proximity egress path marking systems
E4-031	Photoluminescent Floor proximity egress path marking systems
E4-033	Photoluminescent Floor proximity egress path marking systems
E4-051	Photoluminescent Floor proximity egress path marking systems
E4-053	Photoluminescent Floor proximity egress path marking systems
E4-061	Photoluminescent Floor proximity egress path marking systems
E4-063	Photoluminescent Floor proximity egress path marking systems
E4-071	Photoluminescent Floor proximity egress path marking systems
E4-073	Photoluminescent Floor proximity egress path marking systems
E4031	Photoluminescent Floor proximity egress path marking systems
E4051	Photoluminescent Floor proximity egress path marking systems
E4061	Photoluminescent Floor proximity egress path marking systems
E4071	Photoluminescent Floor proximity egress path marking systems
G3-001	Photoluminescent Floor proximity egress path marking systems
G3001	Photoluminescent Floor proximity egress path marking systems
G4-001	Photoluminescent Floor proximity egress path marking systems
G4001	Photoluminescent Floor proximity egress path marking systems
G5-001	Photoluminescent Floor proximity egress path marking systems
G5001	Photoluminescent Floor proximity egress path marking systems
G6-001	Photoluminescent Floor proximity egress path marking systems
G6-003	Photoluminescent Floor proximity egress path marking systems
G6001	Photoluminescent Floor proximity egress path marking systems

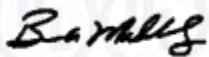

Bruce Mahrenholz, Director North American Certification Program

UL LLC

Any information and documentation involving UL Mark services are provided on behalf of UL LLC (UL) or any authorized licensee of UL. For questions, please contact a local UL Customer Service Representative at <http://ul.com/aboutul/locations/>



CERTIFICATE OF COMPLIANCE

Certificate Number UL-CA-L45151-21-03109102-1
Report Reference SA45151-20190130
Date 13-Sep-2021

H3-001	Photoluminescent Floor proximity egress path marking systems
H3001	Photoluminescent Floor proximity egress path marking systems
H5-001	Photoluminescent Floor proximity egress path marking systems
H5-003	Photoluminescent Floor proximity egress path marking systems
H5001	Photoluminescent Floor proximity egress path marking systems
S5-ARD1010	Photoluminescent Floor proximity egress path marking systems
S5-ARS1010	Photoluminescent Floor proximity egress path marking systems
S5-DHM1010	Photoluminescent Floor proximity egress path marking systems
S5-RM2010	Luminous Egress-Path-Marking Systems
S5-RMDA2010	Luminous Egress-Path-Marking Systems
S5-RMDL2010	Luminous Egress-Path-Marking Systems
S5-RMDR2010	Luminous Egress-Path-Marking Systems
S5-RML2010	Luminous Egress-Path-Marking Systems
S5-RMR2010	Luminous Egress-Path-Marking Systems
S5-RMUA2010	Photoluminescent Floor proximity egress path marking systems
S5-RMUL2010	Luminous Egress-Path-Marking Systems
S5-RMUR2010	Luminous Egress-Path-Marking Systems

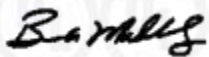

Bruce Mahrenholz, Director North American Certification Program

UL LLC

Any information and documentation involving UL Mark services are provided on behalf of UL LLC (UL) or any authorized licensee of UL. For questions, please contact a local UL Customer Service Representative at <http://ul.com/aboutul/locations/>



CERTIFICATE OF COMPLIANCE

Certificate Number UL-US-L45151-03804102-1
Report Reference SA45151-20140830
Date 13-Jul-2020

Issued to: Ecoglo International Ltd
77 Kingsley St Christchurch
New Zealand 8023

This is to certify that representative samples of IMZI - Luminous Egress-path-marking Systems
See Addendum Page for Product Designation(s).

Have been investigated by UL in accordance with the Standard(s) indicated on this Certificate.

Standard(s) for Safety: UL 1994, 4th Ed., Issue Date: 2015-05-29

Additional Information: See the UL Online Certifications Directory at <https://iq.ulprospector.com> for additional information

This Certificate of Compliance does not provide authorization to apply the UL Mark. Only the UL Follow-Up Services Procedure provides authorization to apply the UL Mark.

Only those products bearing the UL Mark should be considered as being UL Certified and covered under UL's Follow-Up Services.

Look for the UL Certification Mark on the product.

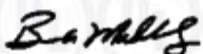

Bruce Mahrenholz, Director North American Certification Program

UL LLC

Any information and documentation involving UL Mark services are provided on behalf of UL LLC (UL) or any authorized licensee of UL. For questions, please contact a local UL Customer Service Representative at <http://ul.com/about/locations/>



CERTIFICATE OF COMPLIANCE

Certificate Number UL-US-L45151-03804102-1
Report Reference SA45151-20140830
Date 13-Jul-2020

This is to certify that representative samples of the product as specified on this certificate were tested according to the current UL requirements

Model	Category Description
G250R, G250R-H, G250R-OB, G250F, UL-PT2518, G300F-OB, UL-HZ2518 and DHM1010	Photoluminescent Floor proximity egress path marking systems

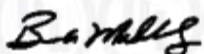

Bruce Mahrenholz, Director North American Certification Program

UL LLC

Any information and documentation involving UL Mark services are provided on behalf of UL LLC (UL) or any authorized licensee of UL. For questions, please contact a local UL Customer Service Representative at <http://ul.com/about/locations/>



CERTIFICATE OF COMPLIANCE

Certificate Number UL-CA-L45151-03804102-1
Report Reference SA45151-20140830
Date 13-Jul-2020

Issued to: Ecoglo International Ltd
77 Kingsley St Christchurch
New Zealand 8023

This is to certify that representative samples of IMZ17 - Luminous Egress-path-marking Systems Certified for Canada

See Addendum Page for Product Designation(s).

Have been investigated by UL in accordance with the Standard(s) indicated on this Certificate.

Standard(s) for Safety: ULC S572, 2nd Ed., Issue Date: 2017-02-01

Additional Information: See the UL Online Certifications Directory at <https://iq.ulprospector.com> for additional information

This Certificate of Compliance does not provide authorization to apply the UL Mark. Only the UL Follow-Up Services Procedure provides authorization to apply the UL Mark.

Only those products bearing the UL Mark should be considered as being UL Certified and covered under UL's Follow-Up Services.

Look for the UL Certification Mark on the product.

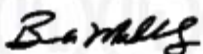

Bruce Mahrenholz, Director North American Certification Program

UL LLC

Any information and documentation involving UL Mark services are provided on behalf of UL LLC (UL) or any authorized licensee of UL. For questions, please contact a local UL Customer Service Representative at <http://ul.com/about/locations/>



CERTIFICATE OF COMPLIANCE

Certificate Number UL-CA-L45151-03804102-1
Report Reference SA45151-20140830
Date 13-Jul-2020

This is to certify that representative samples of the product as specified on this certificate were tested according to the current UL requirements

Model	Category Description
G250R, G250R-H, G250R-OB, G250F, UL-PT2518, G300F-OB, UL-HZ2518 and DHM1010	Photoluminescent Floor proximity egress path marking systems

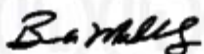

Bruce Mahrenholz, Director North American Certification Program

UL LLC

Any information and documentation involving UL Mark services are provided on behalf of UL LLC (UL) or any authorized licensee of UL. For questions, please contact a local UL Customer Service Representative at <http://ul.com/about/locations/>





REPORT

3933 US ROUTE 11 CORTLAND, NEW YORK 13045

Order No. 3161519

Revised Issue Date: April 2, 2009
Original Issue Date: October 22, 2008

REPORT NO. 3161519CRT-002A

TEST OF PHOTOLUMINESCENT MATERIAL

RENDERED TO

ACCESS PRODUCTS, INC.
55 ROBERTS AVENUE
BUFFALO, NY 14208

Revision Note: Corrected typographical errors.

DATA REQUESTED

Luminance measurements after activation tests and visibility observation tests on photoluminescent material, model nos. G3001, H3001, E2071, E2061, E2051, E3071, E3061 and E3051 in accordance with UL 1994 Test Standard.

AUTHORIZATION

This test service was authorized by signed quote number 500104953.

DEVICES SUBMITTED

The client submitted photoluminescent material samples of Models G3001, H3001, E2071, E2061, E2051, E3071, E3061 and E3051. The samples were received by Intertek on May 7, 2008 in undamaged condition, and tested as received. The sample designations are M08Z301 through M08Z309.

DATE OF TESTS

May 21, 2008 through October 22, 2008

TEST SUMMARY

UL 1994 Models G3001, H3001, E2071, E2061, E2051, E3071, E3061 and E3051

Brightness Rating – Client's Criteria Comply for duration of 195 minutes

Visibility Observation Tests Comply for the duration of 195 minutes at 33 feet distance

This report is for the exclusive use of Intertek's Client and is provided pursuant to the agreement between Intertek and its Client. Intertek's responsibility and liability are limited to the terms and conditions of the agreement. Intertek assumes no liability to any party, other than to the Client in accordance with the agreement, for any loss, expense or damage occasioned by the use of this report. Only the Client is authorized to copy or distribute this report and then only in its entirety. Any use of the Intertek name or one of its marks for the sale or advertisement of the tested material, product or service must first be approved in writing by Intertek. The observations and test results in this report are relevant only to the sample tested. This report by itself does not imply that the material, product, or service is or has ever been under an Intertek certification program. Measurement uncertainty budgets have been determined for applicable test methods and are available upon request



EQUIPMENT LIST

Equipment Used	Model Number	Control Number	Calibration Due Date
Optronic Luminance Standard	455-6-2	Y174	11/15/09
Optronic based Luminance Meter consisting of:			
OptronicPhotometer	730C	E290	06/14/08
Optronic Direct Viewing Module	600	---	---
OptronicAmplifiedPhotodetector	730-5H-LED	---	---
Fisher Scientific Stopwatch	---	N853	06/15/08
UDT Illumination Meter	S371R	L060	01/16/09

TEST AND TEST METHOD

Luminance Measurements

The luminance measurements were made on the photoluminescent test samples with the Intertek License Plate Test Apparatus. The center of each test sample was measured at normal (0°) viewing angle. The aperture of the Optronic based luminance meter was adjusted in order to view the maximum area on the test sample. The Intertek License Plate Test Apparatus consists of an Optronic based luminance meter and a horizontal and vertical movement system. The luminance calibration of the luminance meter is traceable to the National Institute of Standards and Technology through the calibration of the Optronic Luminance Standard. The tests were conducted on May 21, 2008.

The test samples were conditioned for at least 16 hours at zero footcandle illumination. The photoluminescent material samples were then conditioned for 60 minutes (one hour) by 1 footcandle illumination from a 4100K fluorescent light source. Luminance measurements were reported at ninety minutes after conditioning.

Conditioning of Samples for Observation Visibility Test

The samples were conditioned for a minimum of sixteen hours at zero footcandles illumination.

The samples were then conditioned for 60 minutes by 1 footcandle illumination from a fluorescent light source. Then, the exit signs were illuminated with zero footcandle illumination for 90 minutes. Then, the observations were performed. This conditioning was performed before each test.

Selections of Observers

Three observers, having the visual acuity and color vision as specified in Paragraph 40.1.2 of UL 924 were selected for the observations performed at Intertek.

ObservationalVisibilityTest

Each observer made observations for each model under an ambient light conditions of 0 footcandle at 25 feet distance after the samples were conditioned in accordance with UL 1994. For the observations for each model in ambient conditions of 0 footcandle illumination, three test samples were placed at floor level. Each sample was placed in one of three orientations: horizontal, vertical or at 45 degrees to vertical. The conditions in the test ranges were in accordance with UL 1994. Observations were also made at 33 feet at three additional time durations (zero footcandles illumination period). Each observer recorded his observations for the three samples. The observations were made within 15 seconds. All observers must have all correct observations for compliance. This process was repeated for two additional time durations. The three time durations were 90 minutes, 135 minutes and 195 minutes.



RESULTS OF TEST

Luminance Measurements after One Hour Activation Period

Model Nos. G3001, H3001, E2071, E2061, E2051, E3071, E3061 and E3051

Intertek Sample Nos. S08Z815, S08Z816 and S08Z817

Time After Exposure	Luminance (mcd/m ²)				Specified Minimum
	Sample S08Z815	Sample S08Z816	Sample S08Z817	Average	
2 min	90.0	96.0	88.0	91.3	
15 min	42.8	45.0	43.5	43.8	
30 min	27.2	27.9	27.8	27.6	
45 min	20.4	20.9	20.8	20.7	
60 min	15.5	16.3	16.0	15.9	
75 min	13.1	13.2	13.2	13.2	
90 min	10.7	11.0	11.0	10.9	5.0
105 min	9.30	9.50	9.70	9.50	5.0
120 min	8.25	8.40	8.50	8.38	5.0
135 min	7.10	7.25	7.40	7.25	5.0
150 min	6.55	6.75	7.10	6.80	5.0
165 min	5.90	6.15	6.15	6.07	5.0
180 min	5.40	5.60	5.50	5.50	5.0
195 min	4.90	5.00	5.00	4.97	5.0
210 min	4.40	4.70	4.70	4.67#	5.0

- Indicates non-compliance

Observational Visibility Test

Number of Correct Responses
Ambient Illumination Level: 0 Footcandle

Observer Number	Model G3001				Model H3001			
	90 min	90 min	135 min	195 min	90 min	90 min	135 min	195 min
	25 ft	33 ft	33 ft	33 ft	25 ft	33 ft	33 ft	33 ft
1	3	3	3	3	3	3	3	3
2	3	3	3	3	3	3	3	3
3	3	3	3	3	3	3	3	3
Percentage of Correct Observations	100	100	100	100	100	100	100	100
Specified Minimum Percentage	3	3	100	100	3	3	100	100

In Charge of Tests:

David Ellis
Senior Project Engineer
Lighting Division

Report Reviewed By:

Jacki Swiernik
Project Engineer
Lighting Division

Attachment: None



Allunga Exposure Laboratory

Tel: + 61 7 4778 1697
Fax: +61 7 4422 0009
Lat 19°S, 147°E

Email: test@allunga.com.au
Web: www.allunga.com.au

Mail: Locked Bag 369, Aitkenvale
Mail Centre, Queensland,
AUSTRALIA 4814

Attention Delwyn Ralston
Ecoglo International Ltd
77 Kingsley St
Sydenham Christchurch 8023
New Zealand

Report Name Samples / 1-6 @ 20 min @ 150°C
Duration 20 min @ 150°C
Your Reference Samples / 1-6
Our Reference 20D06WW1-6
Report Date 07-Apr-2020

Exposure Type: See Below
Date Exposed 06-Apr-2020

Book & Page: 909/66
Site: Townsville (Main)

Authorised AEL Signatory: Chris Cooper

Notes:

EXPOSURE

Expose samples for 20 minutes at 150°C, as per client instructions.

Instrument: WiseVen WOF-105 Precision Laboratory Oven.

REPORT STANDARDS

VISUAL ASSESSMENT OF CHANGE

Based on Standard: AS/NZS 1580.481.1:1998 Coatings Exposed to Weathering (12 Parameters of Change)

Degree of colour change - AS/NZS 1580.481.1.12

Degree of Blistering - AS/NZS 1580.481.1.9 Blistering

Degree of distortion/shrinkage

AS/NZS, ISO Rating scale: 0-5. 0 = No change, 5 = Complete change

NOTE: AS/NZS 1580.481.1.9 Degree of Blistering

Rating is in two parts, Density (D) and Size (S)

Method 481.1.1.9: Degree of Blistering

0 = None

1 = Less than few

2 = Few

3 = Medium

4 = Medium-dense

5 = Dense

Note: Report prepared >24 Hours post exposure to allow any colour changes associated with energy absorption/radiation to dissipate. Photos taken at 45 minutes and at 24 hours.

Exposure conducted: 06 April 2020.

Report Prepared: 07 April 2020.

Evaluation based on As 1580.481

1.1	General Appearance	1.9 (J)	Blistering
1.2	Discolouration	(K)	Visible Rusting
1.3	Dirt Collection	1.11 (L)	Chalking
1.4	Dirt Retention	1.13	Mould, Algae, Fungus
1.5	Change of Gloss	FIC	Ford Image Clarity
1.6 (E)	Erosion	FD	Film Defects
1.7 (F)	Checking	d	Darker
1.8 (G)	Cracking	l	lighter
1.9 (H)	Flaking & Peeling	r	redder

Colour: D65/10

All Samples Tested As Received

b	bluer
y	yellow
g	greyer
wh	whiter
f	fade
i	increase
c	continued
w	wide variation
t	trace

length measurements in mm

m	includes mould
loc	localized
nnc	no noticeable change
sd	surface distortion
ws	water spotting
af	adhesion failure
S	slight
md	moderate
sv	severe



Allunga Exposure Laboratory

DURABILITY

Tel: + 61 7 4778 1697
Fax: +61 7 4422 0009
Lat 19°S, 147°E

Email: test@allunga.com.au
Web: www.allunga.com.au

Mail: Locked Bag 369, Aitkenvale
Mail Centre, Queensland,
AUSTRALIA 4814

Attention Delwyn Ralston
Ecoglo International Ltd
77 Kingsley St
Sydenham Christchurch 8023
New Zealand

Report Name Samples / 1-6 @ 20 min @ 150°C
Duration 20 min @ 150°C
Your Reference Samples / 1-6
Our Reference 20D06WW1-6
Report Date 07-Apr-2020

Exposure Type: See Below
Date Exposed 06-Apr-2020

Book & Page: 909/66
Site: Townsville (Main)

Authorised AEL Signatory: Chris Cooper

Client Ref	Colour Change	Blistering	Distortion
Hazard tape	0 t	0	1-2
G3-001	0	0	0
S5 sign (1)	0	0	0
S5 sign (2)	0	0	0
S20	0	0	0
A20	1 d g	-	5

Client Ref.	Comments
Hazard tape	Tape has an 'orange peel' wrinkling across whole surface. See photographs
A20	Sample melted onto substrate trapping air in small voids that subsequently expanded giving appearance of blistering, substrate distorted as sample cooled. Exposed material appears a trace darker and greener 24 hours after exposure. See photographs.

Evaluation based on As 1580.481

1.1 General Appearance
1.2 Discolouration
1.3 Dirt Collection
1.4 Dirt Retention
1.5 Change of Gloss
1.6 (E) Erosion
1.7 (F) Checking
1.8 (G) Cracking
1.9 (H) Flaking & Peeling

1.9 (J) Blistering
(K) Visible Rusting
1.11 (L) Chalking
1.13 Mould, Algae, Fungus
FIC Ford Image Clarity
FD Film Defects
d Darker
l lighter
r redder

Colour: D65/10

All Samples Tested As Received

b bluer
y yellower
g greyer
wh whiter
f fade
i increase
c continued
w wide variation
t trace

length measurements in mm

m includes mould
loc localized
nnc no noticeable change
sd surface distortion
ws water spotting
af adhesion failure
S slight
md moderate
sv severe

Appendix 4

Ecoglo International Ltd

Safety Data Sheets

1. Identification

Product Name

Ecoglo Step Nosings and Path Markers including:

F2-003, F4-170, F4-171, F4-151, F6-170, F9-171, F14-173, F14-175, F14-155, F14-2711, F15-173, F15-175, F15-155, G7-001, G7-100, T5-101, T6-101

Manufacturer Details

Company: Ecoglo International Ltd

Address: 77 Kingsley St, Christchurch 8440, New Zealand

Phone No: +64 3 348 3781

2. Hazard Identification

Not classified as hazardous or dangerous as per GHS.

3. Composition/information on ingredients

Component	CAS No.	Proportion
Aluminium Alloy (6063)	-	70-98%
Strontium Aluminate based photoluminescent pigment	-	0-15%
Cross-linked thermoset polyester based resins	-	2-20%
Silicon Carbide	-	0-5%
Other components	-	< 3.4%

4. First-aid measures No special measures required.

5. Fire-fighting measures No special measures required.

6. Accidental release measures Not applicable.

7. Handling and storage Cut edges may be sharp. No special storage requirements.

8. Exposure controls and personal protection Wear gloves when handling.

9. Physical and chemical properties

Appearance:	Solid Strip material
Odour:	N/A
Melting point:	N/A
Specific gravity:	2.2-2.7 g/cc
Volatile:	N/A
Vapour pressure:	N/A
Vapour density:	N/A
Solubility in water:	Insoluble
Flammability:	Not easily combustible. Passes Bombardier SMP 800-C Toxic gas generation test
Explosivity:	Not explosive

10. Stability and reactivity

Hazardous reactions: None known

Radioactivity: Not Radioactive

11. Toxicological information No toxicological properties.

12. Ecological information No ecological hazards.

13. Disposal considerations Offcuts can be sent for aluminium recycling.

14. Transport information Not restricted.

15. Regulatory information None applicable to product.

16. Any other relevant information None.

1. Identification

Product Name

Ecoglo Step Edge Contrast (E Series) including:

E2-071, E2-061, E2-051, E3-071, E3-061, E3-051, E3-075, E3-065, E3-055, E4-071, E4-073, E4-053, E8-071, E10-071, E14-075, E14-055, E15-073, E15-0711

Manufacturer Details

Company: Ecoglo International Ltd

Address: 77 Kingsley St, Christchurch 8440, New Zealand

Phone No: +64 3 348 3781

2. Hazard Identification

Not classified as hazardous or dangerous as per GHS.

3. Composition/information on ingredients

Component

Component	CAS No.	Proportion
Aluminium Alloy (6063)	-	50-80%
Strontium Aluminate based photoluminescent pigment	-	0.5-5%
Cross-linked thermoset polyester based resins	-	10-30%
Silicon Carbide	-	5-20%
Other components	-	< 0.5%

4. First-aid measures No special measures required.

5. Fire-fighting measures No special measures required.

6. Accidental release measures Not applicable.

7. Handling and storage Cut edges may be sharp. No special storage requirements.

8. Exposure controls and personal protection Wear gloves when handling.

9. Physical and chemical properties

Appearance: Solid Strip material

Odour: N/A

Melting point: N/A

Specific gravity: 2.2-2.7 g/cc

Volatile: N/A

Vapour pressure: N/A

Vapour density: N/A

Solubility in water: Insoluble

Flammability: Not easily combustible. Passes Bombardier SMP 800-C Toxic gas generation test

Explosivity: Not explosive

10. Stability and reactivity

Hazardous reactions: None known

Radioactivity: Not Radioactive

11. Toxicological information No toxicological properties.

12. Ecological information No ecological hazards.

13. Disposal considerations Offcuts can be sent for aluminium recycling.

14. Transport information Not restricted.

15. Regulatory information None applicable to product.

16. Any other relevant information None.

1. Identification

Product Name

Ecoglo Guidance Strips and Handrail Markers including:
G3-001, G6-003, G6-011, H3-001, H5-001, MS-26, MS-65

Manufacturer Details

Company: Ecoglo International Ltd
Address: 77 Kingsley St, Christchurch 8440, New Zealand
Phone No: +64 3 348 3781

2. Hazard Identification

Not classified as hazardous or dangerous as per GHS.

3. Composition/information on ingredients

Component

Component	CAS No.	Proportion
Aluminium Alloy (6063)	-	60-80%
Strontium Aluminate based photoluminescent pigment	-	2-15%
Cross-linked thermoset polyester based resins	-	10-30%
Other components	-	<0.2%

4. First-aid measures No special measures required.

5. Fire-fighting measures No special measures required.

6. Accidental release measures Not applicable

7. Handling and storage Cut edges may be sharp. No special storage requirements.

8. Exposure controls and personal protection Wear gloves when handling.

9. Physical and chemical properties

Appearance:	Solid Strip material
Odour:	N/A
Melting point:	N/A
Specific gravity:	2.2-2.7 g/cc
Volatile:	N/A
Vapour pressure:	N/A
Vapour density:	N/A
Solubility in water:	Insoluble
Flammability:	Not easily combustible. Passes Bombardier SMP 800-C Toxic gas generation test
Explosivity:	Not explosive

10. Stability and reactivity

Hazardous reactions:	None known
Radioactivity:	Not Radioactive

11. Toxicological information No toxicological properties.

12. Ecological information No ecological hazards.

13. Disposal considerations Offcuts can be sent for aluminium recycling

14. Transport information Not restricted.

15. Regulatory information None applicable to product.

16. Any other relevant information None.

This information is offered in good faith to the best of our current knowledge. No warranty, expressed or implied, regarding the accuracy of this data, the hazards connected with use of the material, or the results to be obtained from the use thereof, is made. Ecoglo International Ltd. assumes no responsibility for damage or injury from the use of this product.

1. Identification

Product Name

Ecoglo UL 924 Flat Panel Signs including: S20-UL-RMR392223-50, S20-UL-RMR480280-75, S20-UL-RML392223-50, S20-UL-RML480280-75, S20-UL-RMUA392223-50, S20-UL-RMUA480280-75, S20-UL-RMDA392223-50, S20-UL-RMDA480280-75, S20-UL-RMDR392223-50, S20-UL-RMDR480280-75, S20-UL-RMDL392223-50, S20-UL-RMDL480280-75, S20-UL-RMUR392223-50, S20-UL-RMUR480280-75, S20-UL-RMUL392223-50, S20-UL-RMUL480280-75, S20-UL-EX353183-50, S20-UL-EX481249-75, S20-UL-EXR353183-50, S20-UL-EXR481249-75, S20-UL-EXL353183-50, S20-EXL481249-75, S20-UL-EXRL353183-50, S20-UL-EXRL481249-75

Manufacturer Details

Company: Ecoglo International Ltd
Address: 77 Kingsley St, Christchurch 8440, New Zealand
Phone No: +64 3 348 3781

2. Hazard Identification

Not classified as hazardous or dangerous as per GHS.

3. Composition/information on ingredients

Component	CAS No.	Proportion
Aluminium Alloy (5005)	-	40-70%
Strontium Aluminate based photoluminescent pigment	-	10-40%
Cross-linked thermoset polyester based resins	-	10-30%
Other components	-	< 1%

4. First-aid measures No special measures required.

5. Fire-fighting measures No special measures required.

6. Accidental release measures Not applicable.

7. Handling and storage Cut edges may be sharp. No special storage requirements.

8. Exposure controls and personal protection Wear gloves when handling.

9. Physical and chemical properties

Appearance:	Solid sheet material
Odour:	N/A
Melting point:	N/A
Specific gravity:	2.2-2.7 g/cc
Volatile:	N/A
Vapour pressure:	N/A
Vapour density:	N/A
Solubility in water:	Insoluble
Flammability:	Not easily combustible. Passes Bombardier SMP 800-C Toxic gas generation test
Explosivity:	Not explosive

10. Stability and reactivity

Hazardous reactions:	None known
Radioactivity:	Not Radioactive

11. Toxicological information No toxicological properties.

12. Ecological information No ecological hazards.

13. Disposal considerations Offcuts can be sent for aluminium recycling.

14. Transport information Not restricted.

15. Regulatory information None applicable to product.

16. Any other relevant information None.

1. Identification

Product Name

Ecoglo S5 Flat Panel Signs including: S5-RML1010, S5-RMR1010, S5-ARS1010, S5-ARD1010, S5-SI4631, S5-DHM1010, S5-EX230120, S5-EX290155, S5-EXR230120, S5-EXR290155, S5-EXL230120, S5-EXL290155, S5-EXRL310166, S5-RMLFE-228102, S5-RMRFE-228102, S5-SU228102, S5-SD228102, S5-FEXT228102, S5-EVAC210297, S5-EVAC216280, S5-EVAC216330, S5-EVAC457610, S5-EVAC610915, S5-FEXT2010, S5-FH1010, S5-FA1010, S5-BG1010, S5-FEGL2010, S5-RM2010, S5-RMUA2010, S5-RMDA2010, S5-RML2010, S5-RMR2010, S5-RMUL2010, S5-RMDL2010, S5-RMUR2010, S5-RMDR2010

Manufacturer Details

Company: Ecoglo International Ltd
 Address: 77 Kingsley St, Christchurch 8440, New Zealand
 Phone No: +64 3 348 3781

2. Hazard Identification

Not classified as hazardous or dangerous as per GHS.

3. Composition/information on ingredients

Component	CAS No.	Proportion
Aluminium Alloy (5005)	-	70-85%
Strontium Aluminate based photoluminescent pigment	-	5-15%
Cross-linked thermoset polyester based resins	-	10-30%
Other components	-	< 1%

4. First-aid measures No special measures required.

5. Fire-fighting measures No special measures required.

6. Accidental release measures Not applicable.

7. Handling and storage Cut edges may be sharp. No special storage requirements.

8. Exposure controls and personal protection Wear gloves when handling.

9. Physical and chemical properties

Appearance:	Solid sheet material
Odour:	N/A
Melting point:	N/A
Specific gravity:	2.2-2.7 g/cc
Volatile:	N/A
Vapour pressure:	N/A
Vapour density:	N/A
Solubility in water:	Insoluble
Flammability:	Not easily combustible. Passes Bombardier SMP 800-C Toxic gas generation test
Explosivity:	Not explosive

10. Stability and reactivity

Hazardous reactions:	None known
Radioactivity:	Not Radioactive

11. Toxicological information No toxicological properties.

12. Ecological information No ecological hazards.

13. Disposal considerations Offcuts can be sent for aluminium recycling.

14. Transport information Not restricted.

15. Regulatory information None applicable to product.

16. Any other relevant information None.

Appendix 5

Ecoglo International Ltd

Quality Assurance Document

Ecoglo International Ltd QUALITY POLICY

E.I.L is a world leader in the manufacture of photoluminescent signage and path marking. We pride ourselves on our strong focus on compliance and durability. Our policy is to achieve sustainable growth by offering quality products and service. All of our staff are committed to continual quality improvement. The company has earned respect and credibility, at an international level, as a result of our contributions to building code development around photoluminescent system design.

E.I.L maintains an ISO 9001:2016 compliant Business Management System. Management will ensure that all staff are committed to the principles of this system and its continual development.

Our key objectives are:

- To ensure that all products meet contractual and relevant regulatory obligations, both national and international.
- To offer a cost effective and sustainable alternative to traditional electrical lighting that all areas of industry can adopt in a safe and practical manner.
- To offer the most durable photoluminescent products on the market and back them with the best warranty and after-sales support.
- To identify and implement new processes to reduce our product cost without increasing our environmental impact.

Our strategy to achieve these goals is:

- Maintain a high level of staff input on quality control.
- Focus on keeping our staff fully aware of our expected quality output.
- Explore all opportunities to improve our products and processes.
- Effectively recognise the limitations of our product range and work with our clients and competitors to deliver the best result for our clients.
- Be active and engaged in the wider fire safety industry.
- Review any complaints or criticism and use them to construct educational material that assists all levels of industry, both national and international.

Ecoglo International Ltd.

77 Kingsley Street
Christchurch, New Zealand
www.ecoglo.com

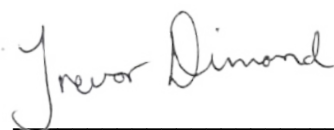
Signed: 
 Name: Trevor Dimond
 Date: 10 October 2019

Appendix 6

Ecoglo International Ltd

Warranties

Ecoglo International Limited

Warranty for Photoluminescent Performance of HTC* Signs and Products

1. We warrant the photoluminescent performance of both Signs and Products, manufactured using our High Temperature Curing (HTC) process, for a period of:

thirty years from the date of installation for standard Signs and Products which are positioned **indoors**; and

fifteen years from the date of installation for **outdoor** Signs (specially coated for **outdoor** conditions) and Products which are positioned **outdoors**.
2. This warranty assumes correct installation and normal conditions of use and maintenance but does not cover normal wear and tear. This warranty does not cover deterioration due to abuse, mistreatment, natural disasters (e.g. fire, flood), exposure to harmful chemicals or environments or any other use or exposure not recommended in our product literature. In particular, this warranty is void in the following circumstances:
 - 2.1 The Signs and/or Products have been misused, neglected, damaged, abused or involved in an accident.
 - 2.2 The Signs and/or Products have been improperly installed, operated, repaired or maintained.
 - 2.3 The Signs and/or Products have been modified.
 - 2.4 The Signs and/or Products have been used outside their stated specifications, capacity and operating parameters.
3. If you have a claim that, in our reasonable judgement, satisfies the terms of this warranty, we shall replace the defective Sign or Product (material only).
4. This is an express warranty. It is your sole and exclusive remedy. We disclaim any other express or implied warranties, including warranties of merchantability or fitness for purpose, to the maximum extent permitted by law. Under no circumstances shall we accept liability for any injury to persons, damage to property, loss of profits, loss of operations or other direct, indirect, special, incidental, or consequential losses, costs and damages whether incurred by you, your guests, licensees, invitees or other third parties. Our liability under any circumstance, whether in contract, tort or otherwise, shall not, in the aggregate, exceed the price that you paid for the Sign and/or Product.
5. Some countries do not allow certain disclaimers, limitations or exclusions in warranties. Therefore, the above disclaimers, limitations and exclusions may not apply to you. This warranty gives you specific legal rights. You may have other rights or remedies pursuant to the laws of your country. Nothing in this limited warranty should be construed as limiting or restricting any other right or remedy available to you, except as allowed by the law in your country.

*Manufactured using High Temperature Curing (HTC)

Ecoglo International Limited

Warranty for Photoluminescent Performance of Non-HTC (High Temperature Curing) Products

1. We warrant the photoluminescent performance of non-HTC Products for a period of:
three years from the date of installation for Products which are positioned **indoors only**.
2. This warranty assumes correct installation and normal conditions of use and maintenance but does not cover normal wear and tear. This warranty does not cover deterioration due to abuse, mistreatment, natural disasters (e.g. fire, flood), exposure to harmful chemicals or environments or any other use or exposure not recommended in our product literature. In particular, this warranty is void in the following circumstances:
 - 2.1 The Products have been misused, neglected, damaged, abused or involved in an accident.
 - 2.2 The Products have been improperly installed, operated, repaired or maintained.
 - 2.3 The Products have been modified.
 - 2.4 The Products have been used outside their stated specifications, capacity and operating parameters.
3. If you have a claim that, in our reasonable judgement, satisfies the terms of this warranty, we shall replace the defective Product (material only).
4. This is an express warranty. It is your sole and exclusive remedy. We disclaim any other express or implied warranties, including warranties of merchantability or fitness for purpose, to the maximum extent permitted by law. Under no circumstances shall we accept liability for any injury to persons, damage to property, loss of profits, loss of operations or other direct, indirect, special, incidental, or consequential losses, costs and damages whether incurred by you, your guests, licensees, invitees or other third parties. Our liability under any circumstance, whether in contract, tort or otherwise, shall not, in the aggregate, exceed the price that you paid for the Product.
5. Some countries do not allow certain disclaimers, limitations or exclusions in warranties. Therefore, the above disclaimers, limitations and exclusions may not apply to you. This warranty gives you specific legal rights. You may have other rights or remedies pursuant to the laws of your country. Nothing in this limited warranty should be construed as limiting or restricting any other right or remedy available to you, except as allowed by the law in your country.

Appendix 7

Ecoglo International Ltd

Maintenance and Cleaning Instructions

Instructions For

Maintenance and Cleaning

Exit Signs and Escape Path Markings



Maintenance and Cleaning Instructions For Exit Signs and Escape Path Markings

Overview

- Regular maintenance and cleaning to remove any obstructions or built up dirt and deposits will ensure the Ecoglo products continue performing to expectation.
- The photoluminescence will continue performing even after UV exposure or exposure to moisture.

Floor Mounted Products

- Check nothing is covering up the product.
- Visually inspect for any sign of damage.
- Vacuuming or brushing with a stiff bristle head brush (dry or wet) is often enough to keep the strips clean.
- The glowing strip can also be wiped clean with a (dry or wet) sponge or cloth.
- High-pressure water (but not steam cleaning) can also be used.
- Observation will determine if cleaning is required however a regular clean every 4 to 6 weeks or after particularly heavy use should ensure correct performance.

Wall Mounted Products

- Check nothing is covering up the sign.
- Visually inspect for any sign of damage.
- Dusting with a soft cloth or brush is often enough to keep the signs clean.
- The glowing material can also be wiped clean with a (dry or wet) sponge or cloth.
- Observation will determine if cleaning is required.

Note

- Do not use highly alkaline or acidic cleaning agents. The pH of the cleaning agents should be between pH 5 and pH 12.
- If cleaning agents are applied at more than pH 10, the Ecoglo material should be rinsed with pH neutral (pH 6 to pH 8) solution afterwards.

For more detailed information re inspection and maintenance procedures for signs please see Photoluminescent Lighting Council Standard PLCS 101 2019, Part C - Inspection and Maintenance (available for download from the Homepage at www.plcouncil.com.au)

Ecoglo International Limited

Email: info@ecoglo.com

Web: www.Ecoglo.com

